





















28 002 978



- Dreifach verstellbar: COMPACT RAIN, COMPACT SOFT FLOW, COMPACT AQUAPRESSURE FLOW, Durchfluss max. 6,8 l/min (bei 3 Bar)
- mit Antikalk-System
- Brausekopf Ø 95 mm
- Anschluss 1/2"
- Dieses Produkt leistet einen Beitrag zur Erfüllung der Vorgaben von nachhaltigen Gebäudezertifizierungen, z.B. LEED®, BREEAM®, DGNB

Eigensicher gegen Rückfließen.

	Chrom	28 002 978-00 0010
	Chrom	28 002 978-00
	Gold (23,9kt)	28 002 978-01
	Platin gebürstet	28 002 978-06
	Platin gebürstet	28 002 978-06 0010
	Platin	28 002 978-08
	Platin	28 002 978-08 0010
	Messing (23kt Gold)	28 002 978-09
	Messing (23kt Gold)	28 002 978-09 0010
	Dark Brass matt	28 002 978-16
	Dark Brass matt	28 002 978-16 0010
	Dark Bronze matt	28 002 978-17
	Dark Bronze matt	28 002 978-17 0010
	Messing gebürstet (23kt Gold)	28 002 978-28
	Messing gebürstet (23kt Gold)	28 002 978-28 0010
	chrom satin	28 002 978-41
	Bronze gebürstet	28 002 978-42
	Bronze gebürstet	28 002 978-42 0010
	Chrom gebürstet	28 002 978-93 0010
	Chrom gebürstet	28 002 978-93
	Dark Platinum gebürstet	28 002 978-99
	Dark Platinum gebürstet	28 002 978-99 0010

28 002 978

mm [inches]

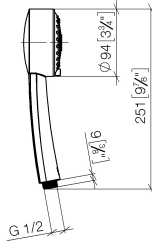

Codes & Standards

ASME A112.18.1 cUPC DIN 4109 EPA WaterSense

ISO 3822 Ü-Zeichen WaterSense



Zertifikate

IAPMO_11777 LGA_18 IAPMO_4976 (

28 002 978

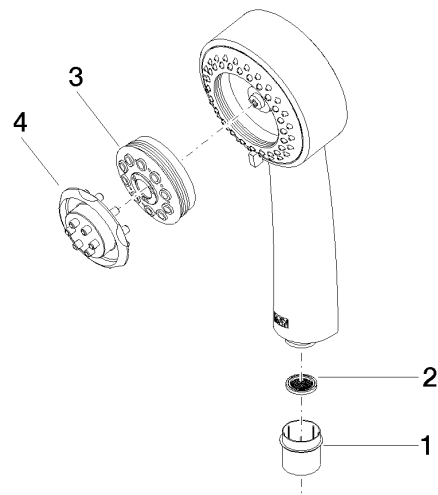

Ersatzteilstückliste

Nr.	Artikelnummer	Benennung	Verbaumenge	Lieferzeit
1	09 21 02 115 90	Bauschutzkappe Schutzkappe für Handbrause Ø 26 x 25 mm -	1,00	2
3	04 12 11 071 00 90	Reguliereinsatz Verstelleinheit Handbrause 31 x 191 x 50 mm -	1,00	2
4	09 30 09 022 90	Montageschlüssel -	1,00	2
2	09 23 01 039 90	Siebdichtung Ø 19 x 5,5 mm -	1,00	2