

























	Platin gebürstet	10 100 970-06
	Chrom	10 100 970-00
	Gold (23,9kt)	10 100 970-01
	bronze	10 100 970-02
	altmessing	10 100 970-03
	chrom edelmatt	10 100 970-05
	Platin	10 100 970-08
	Messing (23kt Gold)	10 100 970-09
	Messing (23kt Gold)	10 100 970-0918
	Weiß matt	10 100 970-10
	weiß	10 100 970-12
	schwarz	10 100 970-13
	Gold gebürstet (23,9kt)	10 100 970-14
	rot (15)	10 100 970-15
	Dark Brass matt	10 100 970-16
	Dark Chrome	10 100 970-19
	Light Gold	10 100 970-26
	Light Gold gebürstet	10 100 970-27
	Messing gebürstet (23kt Gold)	10 100 970-28
	Schwarz matt	10 100 970-33
	chrom satin	10 100 970-41
	Bronze gebürstet	10 100 970-42
	Champagne gebürstet (22kt Gold)	10 100 970-46
	Champagne (22kt Gold)	10 100 970-47
	Chrom gebürstet	10 100 970-93
	Dark Platinum gebürstet	10 100 970-99
	messing matt	10 100 970-29

<input checked="" type="checkbox"/>	grau metallic	10 100 970-30
<input checked="" type="checkbox"/>	schwarz metallic	10 100 970-31
<input checked="" type="checkbox"/>	maron metallic (cu-lack)	10 100 970-32
<input checked="" type="checkbox"/>	royalblau	10 100 970-36



10 100 970 Produktversion ab 01.10.2023

Ersatzteile für die
anderen
Oberflächenvarianten
finden Sie hier:
Chrom

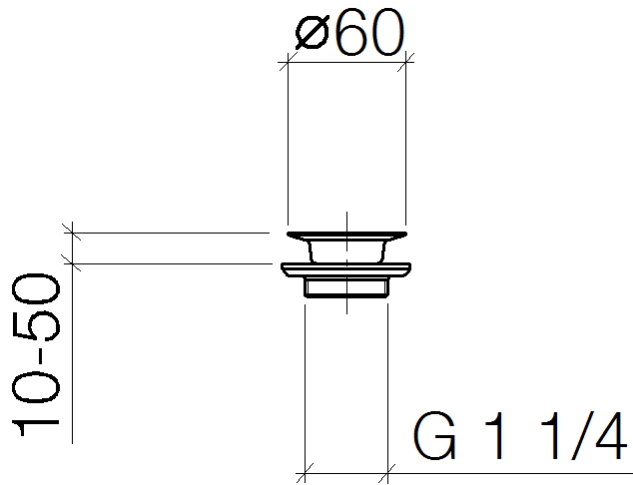
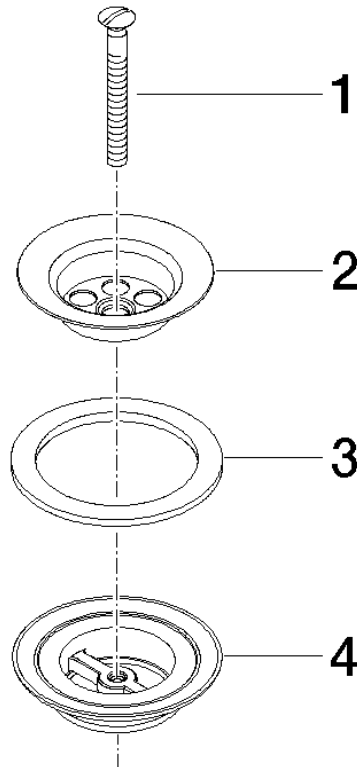

Ersatzteilstückliste

Nr.	Artikelnummer	Benennung	Verbaumenge	Lieferzeit
1	09 30 30 115-06	Abdeckung M6 x 55 mm - Platin gebürstet	1,00	-
Ersatzteil nicht mehr bestellbar, bitte bestellen Sie den Nachfolgeartikel				
3	09 14 03 005 90	Dichtung Ø 50,0 x Ø 70,0 x 6,0 mm -	1,00	-
Ersatzteil nicht mehr bestellbar, bitte bestellen Sie den Nachfolgeartikel				
2	09 11 01 005-06	Ablaufgarnitur Ventilsieb Ø 60 - Platin gebürstet	1,00	-
Ersatzteil nicht mehr bestellbar, bitte bestellen Sie den Nachfolgeartikel				
4	09 11 01 007-07	Ablaufgarnitur Ventilsieb Unterteil 1 1/4" - roh vernickelt	1,00	-
Ersatzteil nicht mehr bestellbar, bitte bestellen Sie den Nachfolgeartikel				