





36 060 670 Produktversion ab 01.06.2024

- Abdeckplatte 80 x 80 mm



	Messing gebürstet (23kt Gold)	36 060 670-28
	Chrom	36 060 670-00
	Platin gebürstet	36 060 670-06
	Platin	36 060 670-08
	Dark Brass matt	36 060 670-16
	Dark Bronze matt	36 060 670-17
	Dark Chrome	36 060 670-19
	Light Gold gebürstet	36 060 670-27
	Schwarz matt	36 060 670-33
	Bronze gebürstet	36 060 670-42
	Champagne gebürstet (22kt Gold)	36 060 670-46
	Champagne (22kt Gold)	36 060 670-47
	Chrom gebürstet	36 060 670-93
	Dark Platinum gebürstet	36 060 670-99

Benötigtes Zubehör



- UP-Wand-Einhandbatterie -** 35 860 970 90
- Min. Einbautiefe 80 mm
 - Max. Einbautiefe 95 mm

36 060 670 Produktversion ab 01.06.2024

mm [inches]

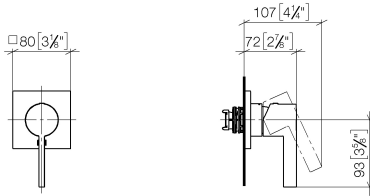

Durchflussdiagramm

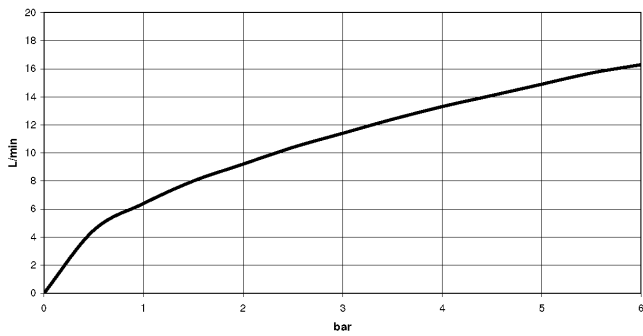

Codes & Standards

DIN 4109

ISO 3822

Scottish Water
Byelaws

UK Water Supply
Regulations

Ü-Zeichen



UP-Einhandbatterie mit Abdeckplatte - Messing gebürstet (23kt Gold)

SERIENSPEZIFISC

36 060 670 Produktversion ab 01.06.2024

Zertifikate

LGA_29

WRAS_2107

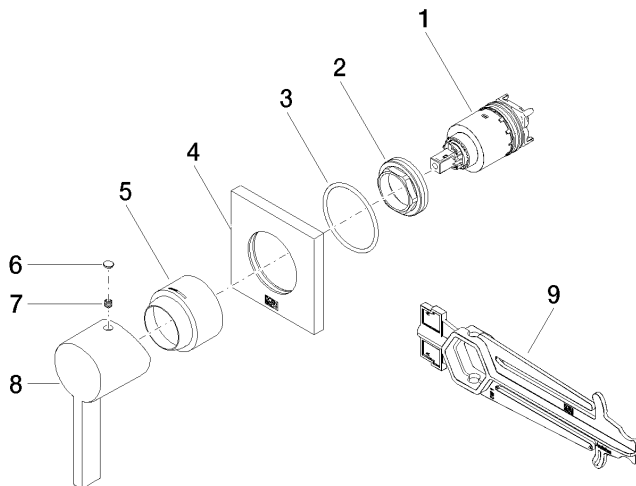

Ersatzteilstückliste

Nr.	Artikelnummer	Benennung	Verbaumenge	Lieferzeit
9	90 30 09 064 00 90	Montageschlüssel für Kartuschenmutter -	1,00	2
6	90 31 20 087 00-28	Abdeckung Ø 7 x 2,1 mm - Messing gebürstet (23kt Gold)	1,00	20
3	90 14 10 049 00 90	O-Ring 45,69 x 2,62 mm -	1,00	2
7	90 31 11 112 00 90	Befestigung Gewindestift M5 x 6 mm -	1,00	2
5	09 11 02 530-28	Haube Ø 45 x 34,5 mm - Messing gebürstet (23kt Gold)	1,00	20
8	09 20 67 004-28	Griff Hebel 45 x 46 x 116 mm - Messing gebürstet (23kt Gold)	1,00	20
4	09 27 78 048-28	Rosette für Mischer 80 x 80 x 9 mm - Messing gebürstet (23kt Gold)	1,00	20
1	90 15 05 064 01 90	EHM Kartusche mit Adapterplatte inkl. Montageschlüssel Ø 35 mm x 58,6 mm -	1,00	2
2	09 24 04 105 90	Befestigung Ø 40 x 12 mm -	1,00	2