

TARA Shower Pipe mit Brausebatterie ohne Handbrause FlowReduce 220 mm - Messing gebürstet (23kt Gold)

TARA















26 632 892 Produktversion ab 01.04.2024



- Ausladung Standbrause 420 mm
- Kopfbrause: Regenstrahl
- Regenbrause Ø 220 mm
- Regenbrause mit Antikalk-System
- Durchfluss Regenbrause max. 7 l/min (bei 3 Bar)
- Drehumstellung Standbrause/ Handbrause
- Höhe Armatur bis Regenbrause (Unterkante) 1007 mm
- Höhe Armatur bis Oberkante Bogen 1167 mm
- Rosette für Brausehalter Ø 55 mm
- Rosette für Wandbefestigung Ø 57 mm
- Rosette für Brausebatterie Ø 65 mm
- Stichmaß 150 mm ± 13 mm
- Metallbrauseschlauch 1500 mm
- Anschluss 1/2"
- Rohrdurchmesser 20 mm
- mit Leerlauf-Funktion
- Dieses Produkt leistet einen Beitrag zur Erfüllung der Vorgaben von nachhaltigen Gebäudezertifizierungen, z.B. LEED®, BREEAM®, DGNB

Dieser Artikel enthält keine Handbrause!

Eigensicher gegen Rückfließen.

	Messing gebürstet (23kt Gold)	26 632 892-28
	Chrom	26 632 892-00
	Platin gebürstet	26 632 892-06
	Platin	26 632 892-08
	Weiß matt	26 632 892-10
	Dark Brass matt	26 632 892-16
	Dark Bronze matt	26 632 892-17
	Dark Chrome	26 632 892-19
	Light Gold gebürstet	26 632 892-27
	Schwarz matt	26 632 892-33
	Bronze gebürstet	26 632 892-42
	Champagne gebürstet (22kt Gold)	26 632 892-46
	Champagne (22kt Gold)	26 632 892-47
	Chrom gebürstet	26 632 892-93
	Dark Platin gebürstet	26 632 892-99

**TARA Shower Pipe mit Brausebatterie ohne Handbrause FlowReduce 220 mm
- Messing gebürstet (23kt Gold)**

TARA

26 632 892 Produktversion ab 01.04.2024

Benötigtes Zubehör

	Handbrause FlowReduce - Messing gebürstet (23kt Gold)	28 018 979-28 0010
---	--	-----------------------

Benötigtes Zubehör

	SERIENNEUTRAL Handbrause FlowReduce - Messing gebürstet (23kt Gold)	28 029 979-28 0010
---	--	-----------------------

Benötigtes Zubehör

	Handbrause - Messing gebürstet (23kt Gold)	28 018 979-28
---	---	---------------

Benötigtes Zubehör

	Handbrause - Messing gebürstet (23kt Gold)	28 012 979-28
---	---	---------------

Benötigtes Zubehör

	SERIENNEUTRAL Handbrause FlowReduce - Messing gebürstet (23kt Gold)	28 025 979-28 0010
---	--	-----------------------

Benötigtes Zubehör

	Handbrause FlowReduce - Messing gebürstet (23kt Gold)	28 012 979-28 0010
---	--	-----------------------

Benötigtes Zubehör

	Handbrause - Messing gebürstet (23kt Gold)	28 015 979-28
---	---	---------------

Benötigtes Zubehör

	Handbrause - Messing gebürstet (23kt Gold)	28 017 979-28
---	---	---------------

Benötigtes Zubehör

	Handbrause - Messing gebürstet (23kt Gold)	28 016 979-28
---	---	---------------

Benötigtes Zubehör

	SERIENNEUTRAL Handbrause FlowReduce - Messing gebürstet (23kt Gold)	28 027 979-28 0010
---	--	-----------------------

Benötigtes Zubehör

	Handbrause FlowReduce - Messing gebürstet (23kt Gold)	28 016 979-28 0010
---	--	-----------------------

**TARA Shower Pipe mit Brausebatterie ohne Handbrause FlowReduce 220 mm
- Messing gebürstet (23kt Gold)**

TARA

26 632 892 Produktversion ab 01.04.2024
mm [inches]
1:10

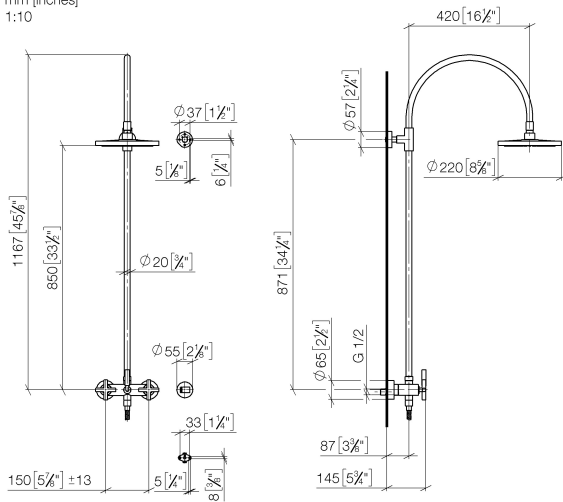

Durchflussdiagramm

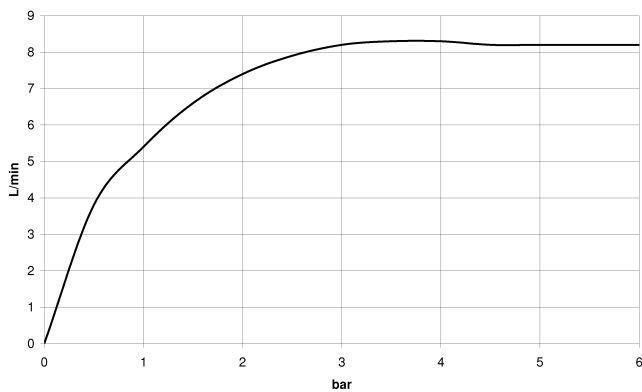

Codes & Standards

DIN 4109

EN 1717

ISO 3822

Scottish Water
Byelaws

UK Water Supply
Regulations

Ü-Zeichen



TARA Shower Pipe mit Brausebatterie ohne Handbrause FlowReduce 220 mm
- Messing gebürstet (23kt Gold)

TARA

26 632 892 Produktversion ab 01.04.2024

Zertifikate

Belgaqua_21-023-2 WRAS_2204

LGA_38

TARA Shower Pipe mit Brausebatterie ohne Handbrause FlowReduce 220 mm - Messing gebürstet (23kt Gold)

TARA

26 632 892 Produktversion ab 01.04.2024

Ersatzteile für die
anderen
Oberflächenvarianten
finden Sie hier:
Chrom

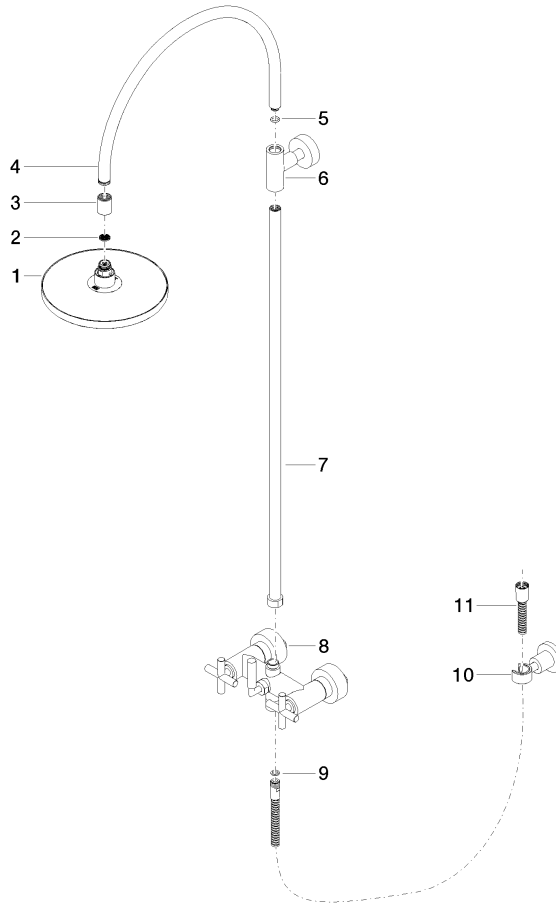

Ersatzteilstückliste

Nr.	Artikelnummer	Benennung	Verbaumenge	Lieferzeit
2	09 23 01 039 90	Siebichtung Ø 19 x 5,5 mm -	1,00	2
9	90 14 20 026 00 90	Dichtung 14 x 8 x 2 mm Centellen WS 3820 -	1,00	2
6	90 17 11 037 00-28	Befestigung für Brause Stand T-Stück - Messing gebürstet (23kt Gold)	1,00	20
5	90 14 10 011 00 90	O-Ring EPDM 70 11,0 x 2,5 mm -	1,00	2
1	90 12 05 092 20-28	Regenbrause rund Ø 220 mm - Messing gebürstet (23kt Gold)	1,00	20
4	04 28 22 097 20-28	Auslauf 297 x 447 x 29 mm - Messing gebürstet (23kt Gold)	1,00	20
7	90 28 22 096 00-28	Rohr 830 mm - Messing gebürstet (23kt Gold)	1,00	20
3	09 24 03 177 20-28	Anschluss Adapter für Regenbrause Ø 25 x 30 mm - Messing gebürstet (23kt Gold)	1,00	20
11	28 304 970-28	Metall-Brauseschlauch 1/2" x 3/8" x 1500 mm - Messing gebürstet (23kt Gold)	1,00	20
10	28 050 892-28	TARA Brausehalter - Messing gebürstet (23kt Gold)	1,00	20
8	04 17 10 020 01-28	Anschluss für Wanne Wand 200 x 215 x 140 mm - Messing gebürstet (23kt Gold)	1,00	20