

Datenblatt

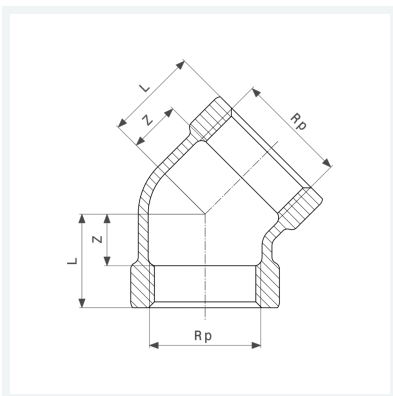

Bogen 45°
- Rp-Gewinde
Modell 3120

Artikel 320 652



Eigenschaften

Innengewinde zylindrisch	Rp	1
Z-Maß	Z	9 mm
Länge	L	28 mm
Gewicht	212 g	
Volumen	248,64 cm ³	
Werkstoff	Rotguss oder Siliziumbronze	