















25 023 360



- Ausladung 160 mm
- Handbrause: COMPACT RAIN, Durchfluss max. 9 l/min (bei 3 Bar)
- Auslauf: rechteckiger Normalstrahl
- Brausehalter
- Drehumstellung Wanne/Brause
- Rosette Ø 70 mm
- Anschluss 1/2"
- Stichmaß 153 mm
- Metallbrauseschlauch 1250 mm mit integriertem Verdrehenschutz
- Durchfluss Auslauf max. 26 l/min

Eigensicher gegen Rückfließen.

	Chrom	25 023 360-00
	Chrom	25 023 360-00 0030
	Gold (23,9kt)	25 023 360-01
	bronze	25 023 360-02
	Platin gebürstet	25 023 360-06
	Platin	25 023 360-08
	Messing (23kt Gold)	25 023 360-09
	weiß	25 023 360-12
	Dark Brass matt	25 023 360-16
	Dark Bronze matt	25 023 360-17
	Messing gebürstet (23kt Gold)	25 023 360-28
	Bronze gebürstet	25 023 360-42
	Dark Platinum gebürstet	25 023 360-99
	chrom / gold	25 023 360-55

25 023 360

mm [inches]

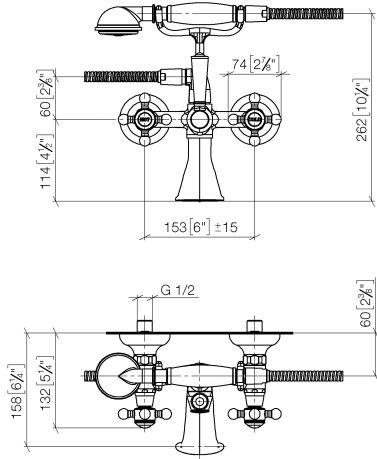

Durchflussdiagramm



Codes & Standards

EN 1717

Scottish Water
Byelaws

UK Water Supply
Regulations



MADISON Wannensbatterie für Wandmontage mit Handbrausegarnitur - Chrom

MADISON

25 023 360

Zertifikate

Belgaqua_21-378-2 WRAS_240702

25 023 360

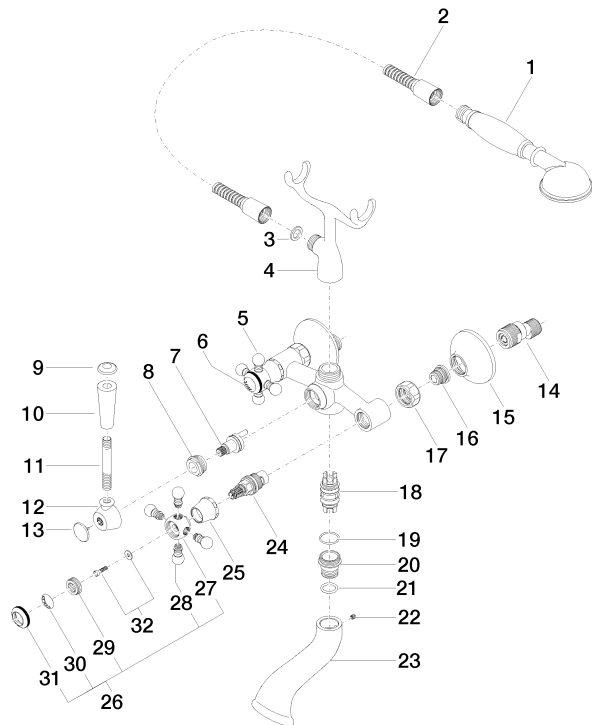

25 023 360

Ersatzteilstückliste

Nr.	Artikelnummer	Benennung	Verbaumenge	Lieferzeit
6	09 26 01 011 90	Abdeckung Porzellanplättchen HOT -	1,00	2
14	04 11 04 030 00 90	S-Anschluss mit Schalldämpfer und Dichtung 1 Paar G1/2 x G3/4 -	2,00	2
5	04 20 36 002 07-00	Griff Hot - Chrom	1,00	10
2	28 104 970-00	Metall-Brauseschlauch 1/2" x 1/2" x 1250 mm - Chrom	1,00	2
8	09 23 10 007 90	Befestigung Mutter M24 x 1,5 mm -	1,00	2
25	09 21 02 055-00	Haube 24 x 29 x 30 mm - Chrom	2,00	10
7	90 15 01 001 00 90	Umstellung -	1,00	2
29	09 20 83 006 90	Griff Ø 21 x 7,5 mm -	2,00	2
24	90 90 03 131 00 90	Oberteil , rechtsschließend 1/2" -	2,00	2
30	09 26 01 010 90	Abdeckung Porzellanplättchen COLD -	1,00	2
28	09 20 36 004-00	Griff 15 x 15 x 28 mm - Chrom	8,00	10
17	09 23 30 010-00	Befestigung Überwurfmutter 3/4" - Chrom	2,00	10
19	90 14 10 056 00 90	O-Ring EPDM 70 21,45 x 1,78 mm -	1,00	2
4	04 17 20 010 00-00	Halter 160 x 180 x 55 mm - Chrom	1,00	10
9	09 30 30 062-00	Abdeckung Ø 24 x 8 mm - Chrom	1,00	10
1	28 002 970-00	MADISON Metall-Handbrause mit Porzellangriff (weiß) - Chrom	1,00	10
10	11 170 370-00	MADISON Hebeleinsatz - Chrom	1,00	10
16	04 29 05 014 00 90	Anschluss M18 x 1,5 -	2,00	2
32	04 30 30 029 00 90	Befestigung diebstahlgesichert -	2,00	2
18	90 21 10 010 00 90	Umstellung -	1,00	2
20	09 24 03 123 20 90	Nippel Ø 28 x 27 mm -	1,00	2
15	09 27 39 010-00	Rosette Ø 70 x 31 mm - Chrom	2,00	10
21	09 14 10 022 90	O-Ring EPDM 70 16,0 x 2,5 mm -	1,00	2
3	90 14 20 002 00 90	Dichtung Vf 3110, 18,5 x 12,0 x 2,0 mm -	1,00	2
23	09 11 06 033 20-00	Auslauf 125 x 89 x 67 mm - Chrom	1,00	10
31	09 20 36 005-00	Griff Ø 28 x 7 mm - Chrom	2,00	10
22	90 31 11 030 00 90	Befestigung Gewindestift mit Innensechskant mit Ringschneide M5 x 5 mm -	1,00	2
13	09 30 30 064-00	Abdeckung Ø 25,5 x 15 mm - Chrom	1,00	10
11	09 28 22 013 90	Befestigung Ø 10 x 75 mm -	1,00	2
12	09 18 20 011-00	Mitnehmer 43 x 21 x 36 mm - Chrom	1,00	10
27	09 20 36 002-00	Griff Ø 29,5 x 30 mm - Chrom	2,00	10
26	04 20 36 002 06-00	Griff Cold - Chrom	1,00	10