

























10 110 970 Produktversion ab 01.10.2023



	Messing gebürstet (23kt Gold)	10 110 970-28
	Chrom	10 110 970-00
	Gold (23,9kt)	10 110 970-01
	chrom gebürstet (04)	10 110 970-04
	Platin gebürstet	10 110 970-06
	Platin	10 110 970-08
	Messing (23kt Gold)	10 110 970-09
	Weiß matt	10 110 970-10
	weiß	10 110 970-12
	schwarz	10 110 970-13
	Gold gebürstet (23,9kt)	10 110 970-14
	Dark Brass matt	10 110 970-16
	Dark Bronze matt	10 110 970-17
	Dark Chrome	10 110 970-19
	Light Gold	10 110 970-26
	Light Gold gebürstet	10 110 970-27
	Schwarz matt	10 110 970-33
	chrom satin	10 110 970-41
	Bronze gebürstet	10 110 970-42
	Champagne gebürstet (22kt Gold)	10 110 970-46
	Champagne (22kt Gold)	10 110 970-47
	Cyprum	10 110 970-49
	Chrom gebürstet	10 110 970-93
	Dark Platin gebürstet	10 110 970-99
	royalblau	10 110 970-36



Siebventil 1 1/4" - Messing gebürstet (23kt Gold)

SERIENNEUTRAL

10 110 970 Produktversion ab 01.10.2023

Nur für Becken ohne Überlauf geeignet.

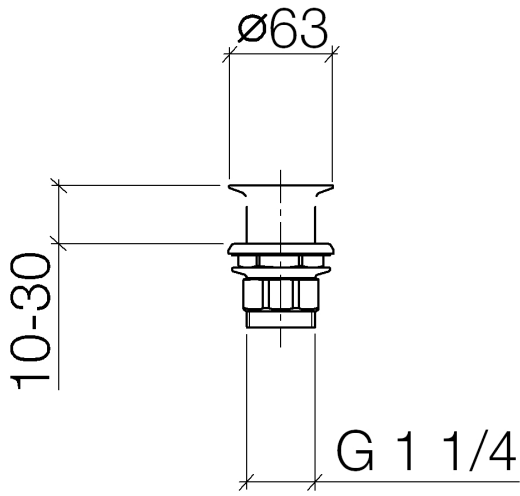

10 110 970 Produktversion ab 01.10.2023

Ersatzteile für die
anderen
Oberflächenvarianten
finden Sie hier:
Chrom

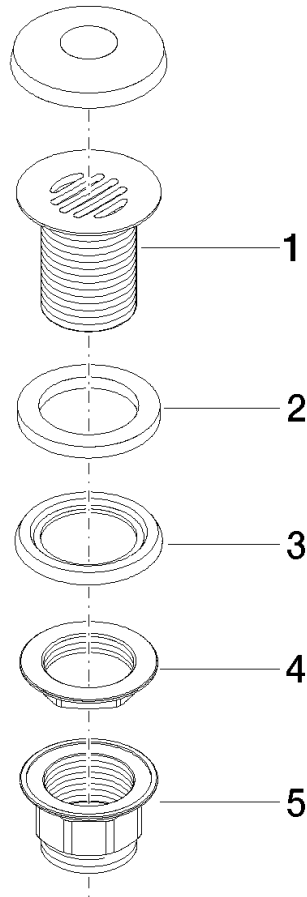

Ersatzteilstückliste

Nr.	Artikelnummer	Benennung	Verbaumenge	Lieferzeit
5	09 23 10 020-28	Befestigung Ø 60 x 36,5 mm - Messing gebürstet (23kt Gold)	1,00	20
4	09 23 10 017 90	Befestigung mit Bund Verschraubung 1 1/4" -	1,00	2
2	09 14 05 039 90	Dichtung 43,5 x 62 x 6 mm -	1,00	2
3	09 14 03 025 90	Dichtung Profildichtung Ø 64 x 6 mm -	1,00	2
1	09 11 01 025-28	Kelch für Ablaufgarnitur 1 1/4" - Messing gebürstet (23kt Gold)	1,00	20