

26 633 892 Produktversion ab 01.04.2024



- Ausladung Standbrause 420 mm
- Kopfbrause: Regenstrahl
- Regenbrause Ø 220 mm
- Regenbrause mit Antikalk-System
- Durchfluss Regenbrause max. 7 l/min (bei 3 Bar)
- Drehumstellung Standbrause/ Handbrause
- Höhe Armatur bis Regenbrause (Unterkante) 1007 mm
- Höhe Armatur bis Oberkante Bogen 1167 mm
- Rosette für Brausehalter Ø 55 mm
- Rosette für Wandbefestigung Ø 57 mm
- Rosette für Brausebatterie Ø 65 mm
- Stichmaß 150 mm ± 13 mm
- Metallbrauseschlauch 1500 mm
- Anschluss 1/2"
- Rohrdurchmesser 20 mm
- mit Leerlauf-Funktion
- Dieses Produkt leistet einen Beitrag zur Erfüllung der Vorgaben von nachhaltigen Gebäudezertifizierungen, z.B. LEED®, BREEAM®, DGNB

Dieser Artikel enthält keine Handbrause!

Eigensicher gegen Rückfließen.

	Chrom	26 633 892-00
	Platin gebürstet	26 633 892-06
	Platin	26 633 892-08
	Weiß matt	26 633 892-10
	Dark Brass matt	26 633 892-16
	Dark Bronze matt	26 633 892-17
	Dark Chrome	26 633 892-19
	Light Gold gebürstet	26 633 892-27
	Messing gebürstet (23kt Gold)	26 633 892-28
	Schwarz matt	26 633 892-33
	Bronze gebürstet	26 633 892-42
	Champagne gebürstet (22kt Gold)	26 633 892-46
	Champagne (22kt Gold)	26 633 892-47
	Chrom gebürstet	26 633 892-93
	Dark Platin gebürstet	26 633 892-99

26 633 892 Produktversion ab 01.04.2024

Benötigtes Zubehör

	Handbrause - Chrom	28 018 979-00
---	---------------------------	---------------

Benötigtes Zubehör

	SERIENNEUTRAL Handbrause FlowReduce - Chrom	28 029 979-00 0010
---	--	-----------------------

Benötigtes Zubehör

	SERIENNEUTRAL Handbrause FlowReduce - Chrom	28 027 979-00 0010
---	--	-----------------------

Benötigtes Zubehör

	Handbrause FlowReduce - Chrom	28 012 979-00 0010
---	--------------------------------------	-----------------------

Benötigtes Zubehör

	Handbrause - Chrom	28 017 979-00
---	---------------------------	---------------

Benötigtes Zubehör

	Handbrause FlowReduce - Chrom	28 016 979-00 0010
---	--------------------------------------	-----------------------

Benötigtes Zubehör

	Handbrause FlowReduce - Chrom	28 018 979-00 0010
---	--------------------------------------	-----------------------

Benötigtes Zubehör

	Handbrause - Chrom	28 012 979-00
---	---------------------------	---------------

Benötigtes Zubehör

	Handbrause - Chrom	28 016 979-00
---	---------------------------	---------------

Benötigtes Zubehör

	Handbrause - Chrom	28 015 979-00
---	---------------------------	---------------

Benötigtes Zubehör

	SERIENNEUTRAL Handbrause FlowReduce - Chrom	28 025 979-00 0010
---	--	-----------------------

Durchflussdiagramm

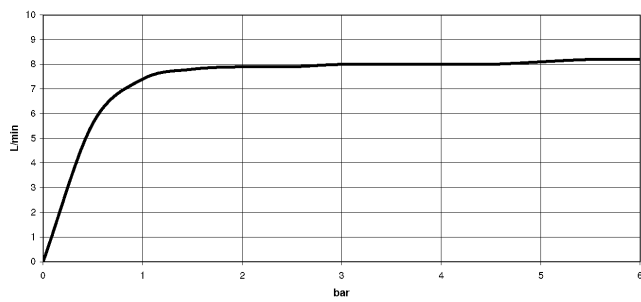

Codes & Standards

DIN 4109

EN 1717

ISO 3822

Scottish Water
Byelaws

UK Water Supply
Regulations

Ü-Zeichen



TARA Shower Pipe ohne Handbrause FlowReduce 220 mm - Chrom

TARA

26 633 892 Produktversion ab 01.04.2024

Zertifikate

Belgaqua_21-023-2 WRAS_2204

LGA_38

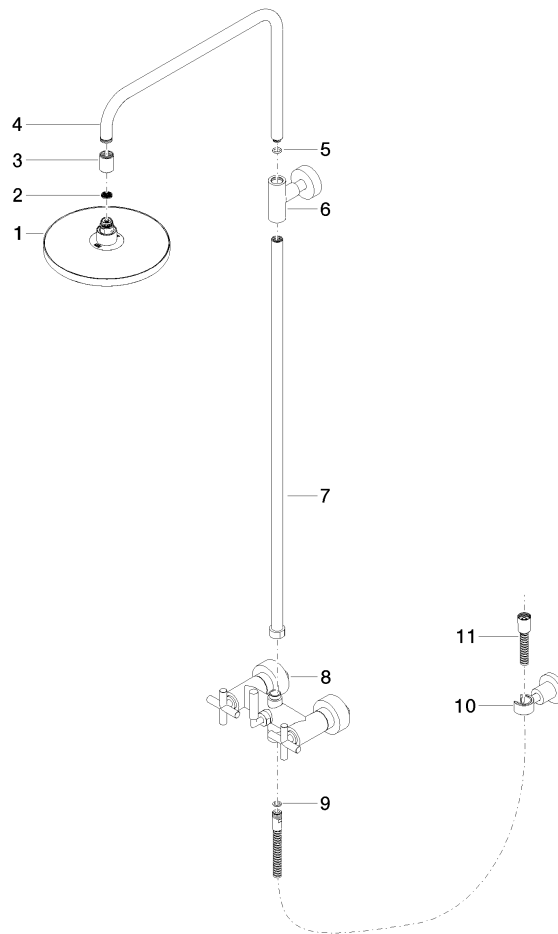

Ersatzteilstückliste

Nr.	Artikelnummer	Benennung	Verbaumenge	Lieferzeit
10	28 050 892-00	TARA Brausehalter - Chrom	1,00	10
4	04 28 22 101 20-00	Auslauf 447,5 x 30 x 297 mm - Chrom	1,00	10
9	90 14 20 026 00 90	Dichtung 14 x 8 x 2 mm Centellen WS 3820 -	1,00	2
3	09 24 03 177 20-00	Anschluss Adapter für Regenbrause Ø 25 x 30 mm - Chrom	1,00	10
2	09 23 01 039 90	Siebdichtung Ø 19 x 5,5 mm -	1,00	2
11	28 304 970-00	Metall-Brauseschlauch 1/2" x 3/8" x 1500 mm - Chrom	1,00	2
7	90 28 22 096 00-00	Rohr 830 mm - Chrom	1,00	10
6	90 17 11 037 00-00	Befestigung für Brause Stand T-Stück - Chrom	1,00	10
5	90 14 10 011 00 90	O-Ring EPDM 70 11,0 x 2,5 mm -	1,00	2
8	04 17 10 020 01-00	Anschluss für Wanne Wand 200 x 215 x 140 mm - Chrom	1,00	10
1	90 12 05 092 20-00	Regenbrause rund Ø 220 mm - Chrom	1,00	10