



















28 508 360



- Ausladung 200 mm
- Kugelgelenk 30° schwenkbar
- Dreifach verstellbar: COMPACT RAIN, COMPACT SOFT FLOW, COMPACT AQUAPRESSURE FLOW, Durchfluss max. 9 l/min (bei 3 Bar)
- Funktion ab: 7 l/min
- mit Antikalk-System
- Brausekopf Ø 94 mm
- Rosette Ø 55 mm
- Anschluss 1/2"

	Messing gebürstet (23kt Gold)	28 508 360-28
	Chrom	28 508 360-00 0010
	Chrom	28 508 360-00
	Gold (23,9kt)	28 508 360-01
	Platin gebürstet	28 508 360-06 0010
	Platin gebürstet	28 508 360-06
	Platin	28 508 360-08 0010
	Platin	28 508 360-08
	Messing (23kt Gold)	28 508 360-09 0010
	Messing (23kt Gold)	28 508 360-09
	Dark Brass matt	28 508 360-16
	Dark Bronze matt	28 508 360-17
	Messing gebürstet (23kt Gold)	28 508 360-28 0010
	Bronze gebürstet	28 508 360-42
	Bronze gebürstet	28 508 360-42 0010
	Dark Platinum gebürstet	28 508 360-99
	Dark Platinum gebürstet	28 508 360-99 0010

Empfohlenes Zubehör

	UP-Wandwinkel - •Min. Einbautiefe 90 mm •Max. Einbautiefe 163 mm	35 085 970 90
---	---	---------------

Empfohlenes Zubehör

	UP-Wandwinkel - •Min. Einbautiefe 90 mm •Max. Einbautiefe 163 mm	35 085 970 90
---	---	---------------

28 508 360

mm [inches]

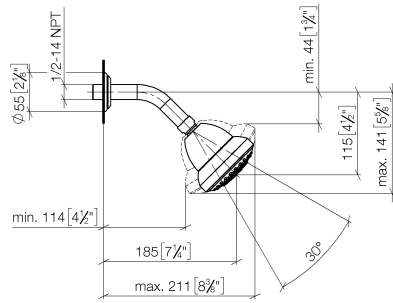

Durchflussdiagramm

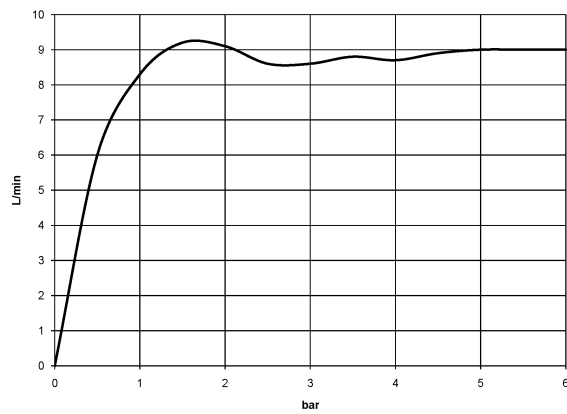

28 508 360

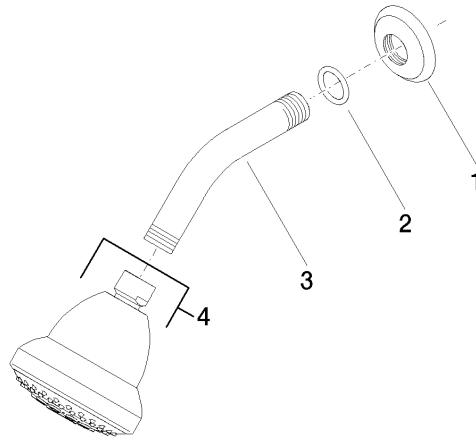

Ersatzteilstückliste

Nr.	Artikelnummer	Benennung	Verbaumenge	Lieferzeit
3	09 11 03 011-28	Anschluss 140 x 65 x 21 mm - Messing gebürstet (23kt Gold)	1,00	20
1	09 27 35 003-28	Rosette Ø 55 x Ø 27 x 10 mm - Messing gebürstet (23kt Gold)	1,00	-
Ersatzteil nicht mehr bestellbar, bitte bestellen Sie den Nachfolgeartikel				
4	04 12 11 120 00-28	Brause Kopfbrause 93 x 113 x 100 mm - Messing gebürstet (23kt Gold)	1,00	-
Ersatzteil nicht mehr bestellbar, bitte bestellen Sie den Nachfolgeartikel				
2	90 14 10 026 00 90	O-Ring 20,5 x 3,5 mm -	1,00	2