











28 679 670 Produktversion ab 13.03.2017



- Ausladung 450 mm
- Regenbrause Ø 300 mm
- PURE RAIN, Durchfluss max. 14 l/min (bei 3 Bar)
- Funktion ab: 10 l/min
- Rosette 65 x 65 mm
- Anschluss 1/2"
- mit Antikalk-System
- mit Leerlauf-Funktion

	Platin	28 679 670-08
	Chrom	28 679 670-00
	Platin gebürstet	28 679 670-06
	Dark Chrome	28 679 670-19
	Light Gold gebürstet	28 679 670-27
	Messing gebürstet (23kt Gold)	28 679 670-28
	Schwarz matt	28 679 670-33
	Champagne gebürstet (22kt Gold)	28 679 670-46
	Champagne (22kt Gold)	28 679 670-47
	Chrom gebürstet	28 679 670-93
	Dark Platinum gebürstet	28 679 670-99

Empfohlenes Zubehör

UP-Wandwinkel -

35 085 970 90



- Min. Einbautiefe 90 mm
- Max. Einbautiefe 163 mm

28 679 670 Produktversion ab 13.03.2017

mm [inches]



Durchflussdiagramm

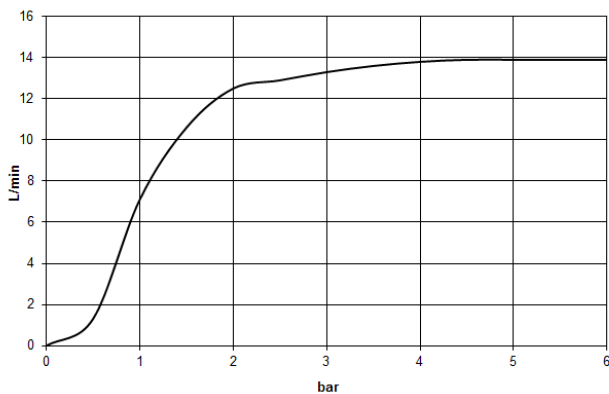

Codes & Standards

DIN 4109

ISO 3822

Scottish Water
Byelaws

UK Water Supply
Regulations

Ü-Zeichen



Regenbrause mit Wandinbindung 300 mm - Platin

SERIENSPEZIFISC

28 679 670 Produktversion ab 13.03.2017

Zertifikate und Nachhaltigkeit

LGA_29

WRAS_2212

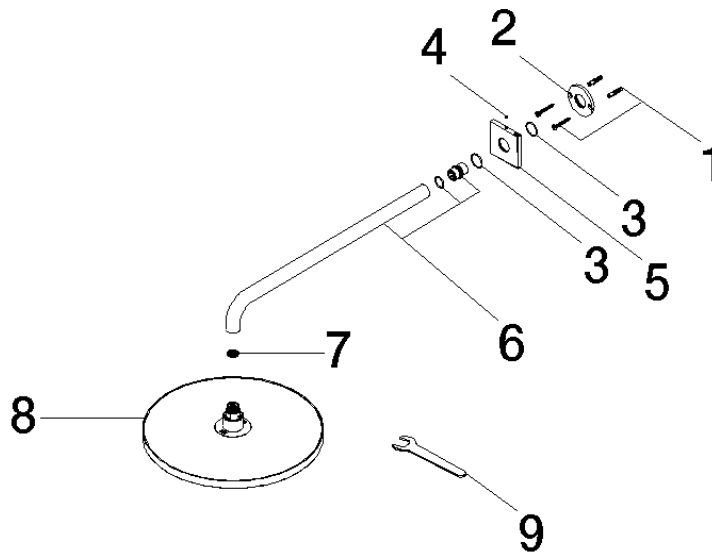

Ersatzteilstückliste

Nr.	Artikelnummer	Benennung	Verbaumenge	Lieferzeit
3	09 14 10 150 90	O-Ring 23 x 1,5 mm -	2,00	2
9	90 30 09 069 00 90	Montageschlüssel -	1,00	2
7	09 23 01 075 90	Siebichtung Ø 18 x 3,5 mm -	1,00	2
8	04 12 05 091 00-08	Regenbrause rund Ø 300 mm - Platin	1,00	40
1	04 30 31 032 00 90	Befestigungssatz Schraube 4 x 35 mm -	1,00	2
6	90 11 03 070 00-08	Rohr 462 x 61 x 24 mm - Platin	1,00	40
2	09 17 20 120 90	Anschluss Ø 56,50 x 5 mm -	1,00	2
4	90 31 11 038 00 90	Befestigung Gewindestift mit Innensechskant mit Ringschneide M4 x 3 mm -	1,00	2
5	09 27 67 015-08	Rosette 65 x 65 x 9 mm - Platin	1,00	40