

Art. Nr. 390 6680 / 6822

Technische Zeichnung

Beleuchtung: 8 Led Lampen, Schutzklasse iP44, Netzteil 12 Volt, Nennstrom ≤30mA
 Optimale Durchflussmenge ab 20 l/min bei 3 bar
 Lighting: 8 Led lamps, Protection class IP44, Power supply 12 V, rated current ≤ 30mA
 Best flow rate of 20 l / min at 3 bar
 Eclairage: 8 lampes LED, Classe de protection IP44, Alimentation 12 V, courant assigné ≤ 30 mA
 Meilleur fonction avec une débit de 20 l / min à 3 bar

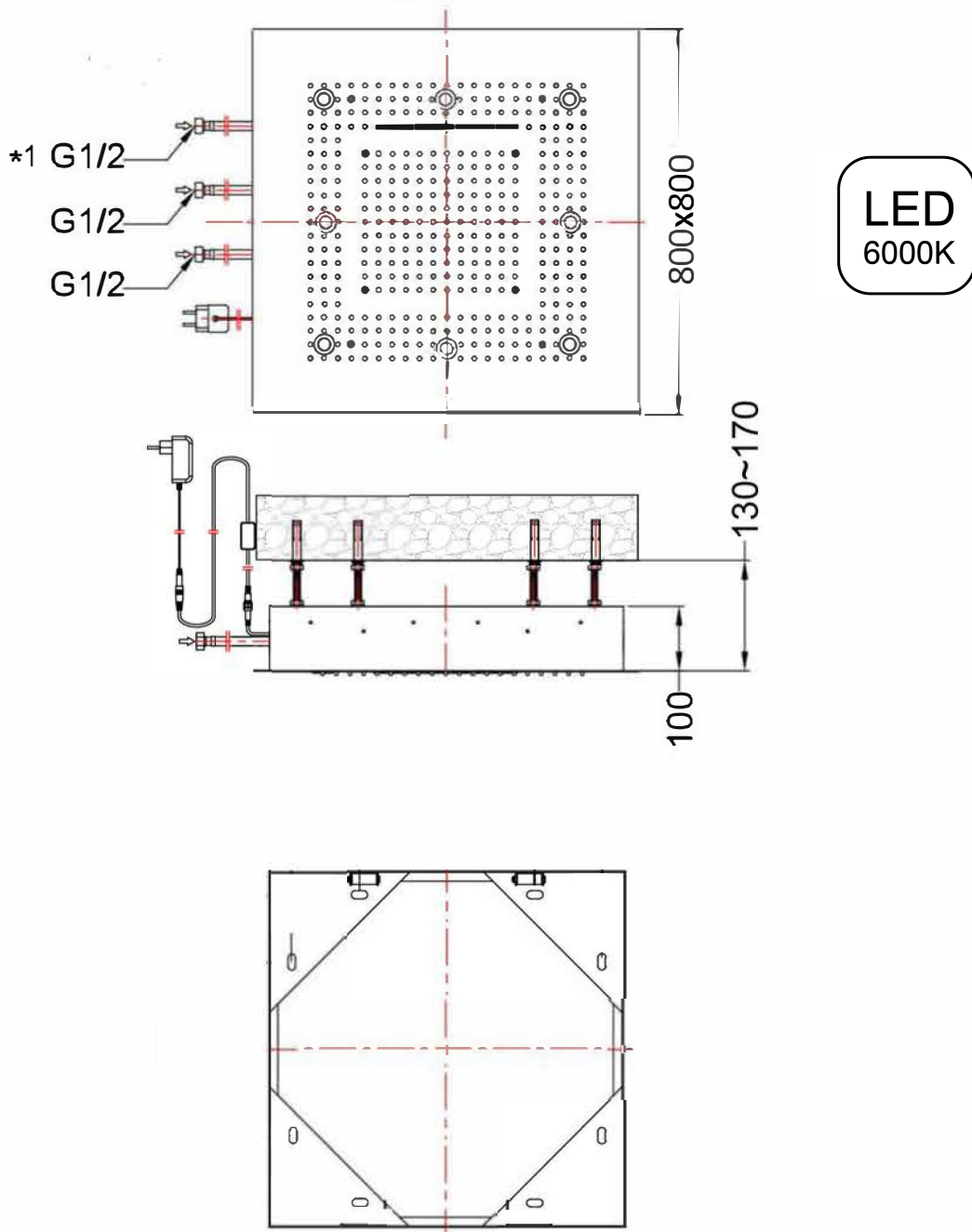

*1 nur bei 6680
 only at 6680

Explosionszeichnung

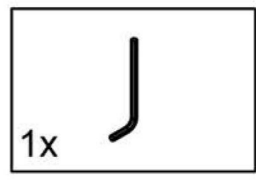
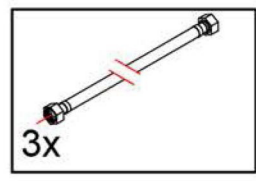
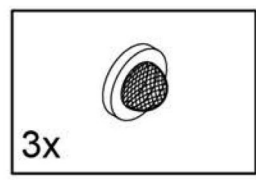
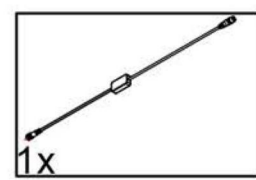
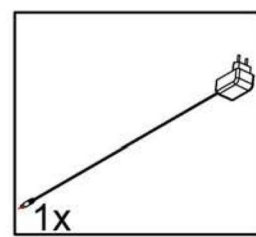
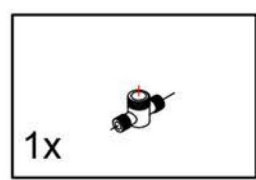
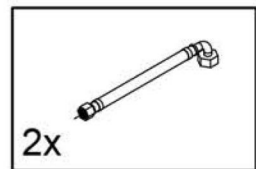
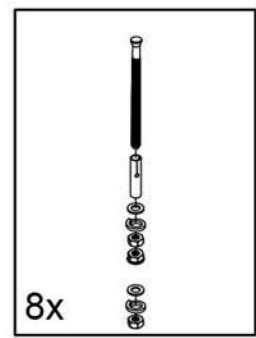
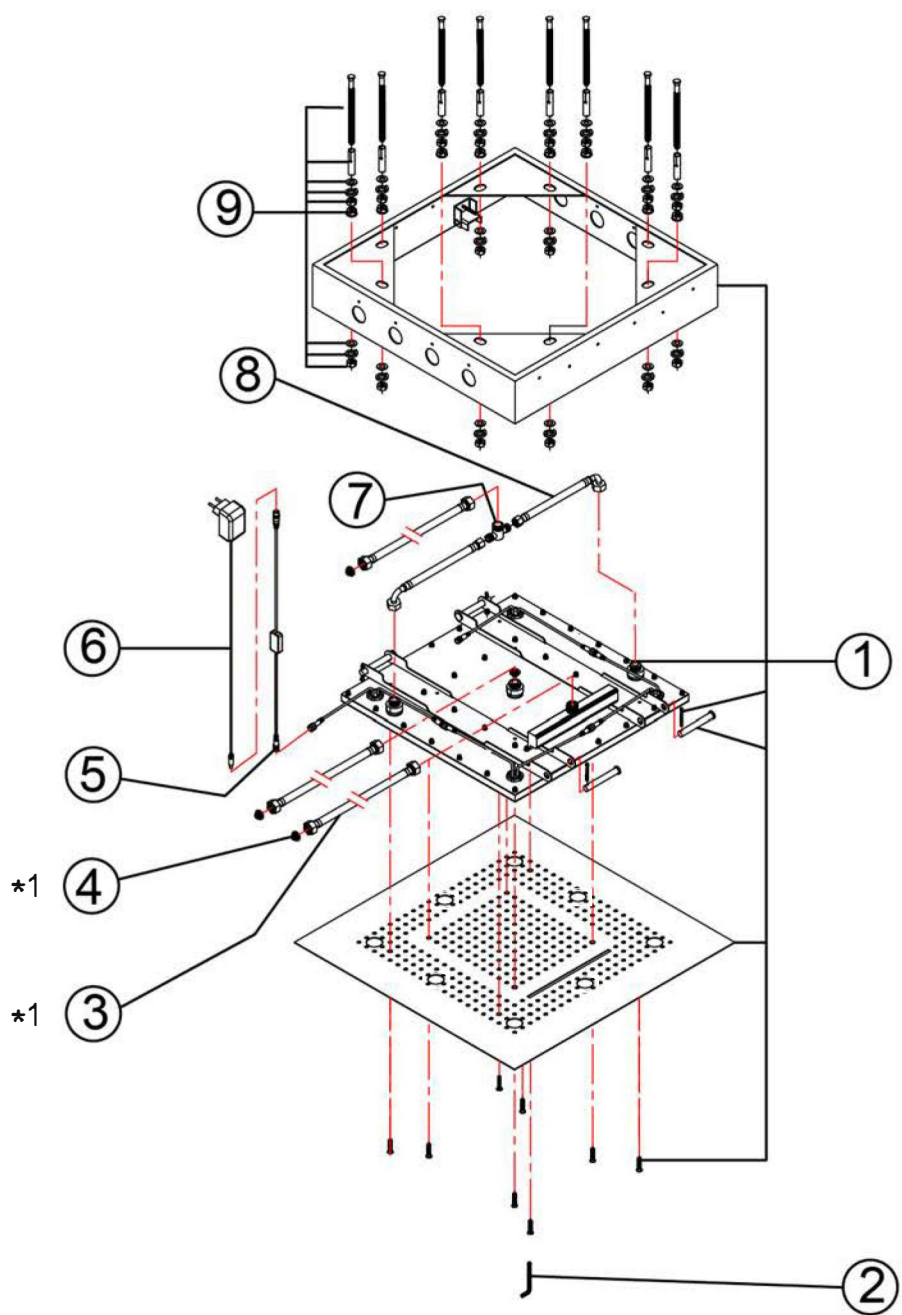

*1 nur bei 6680
only at 6680

Installation

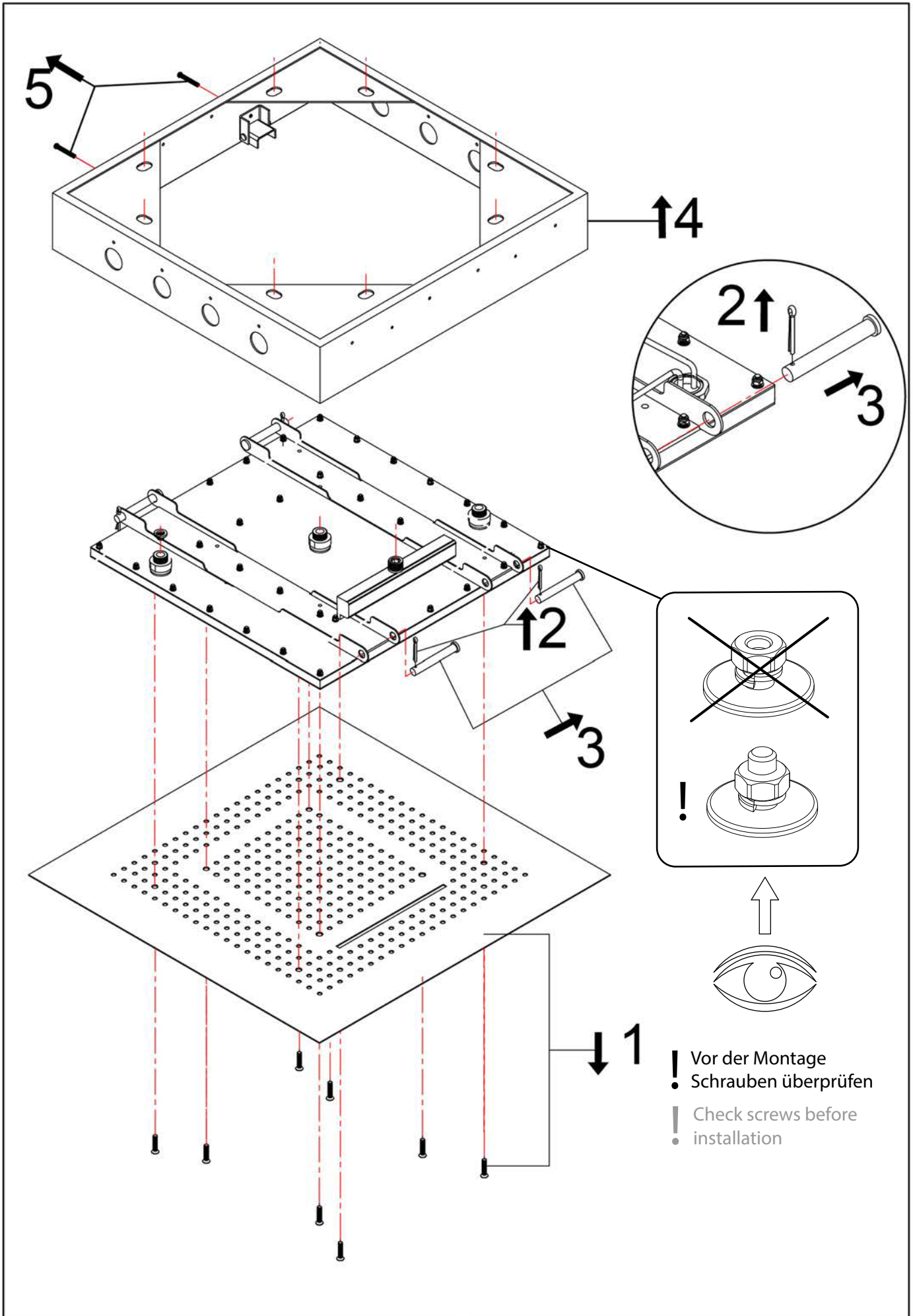

Installation

*1 nur bei 6680
only at 6680

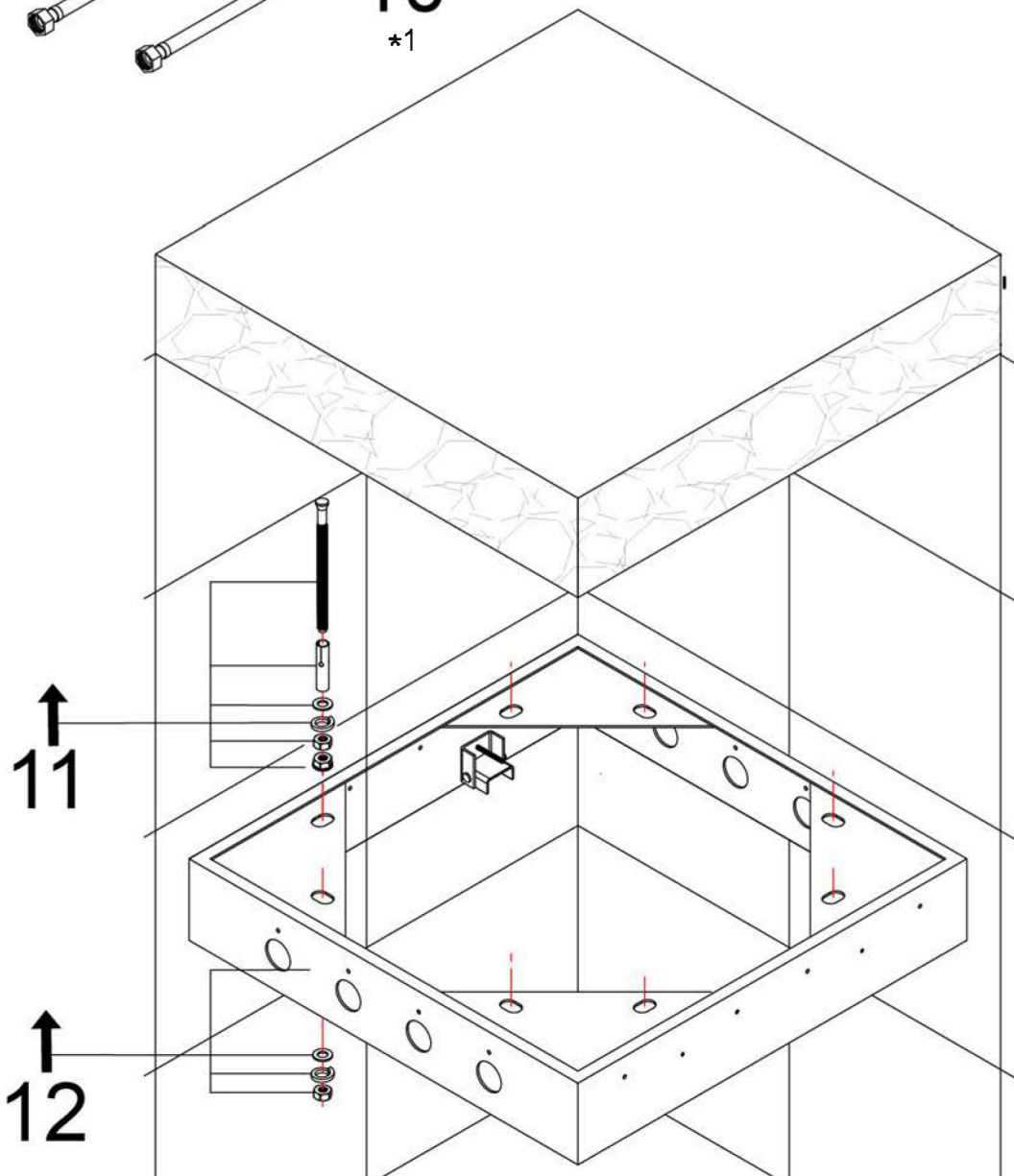
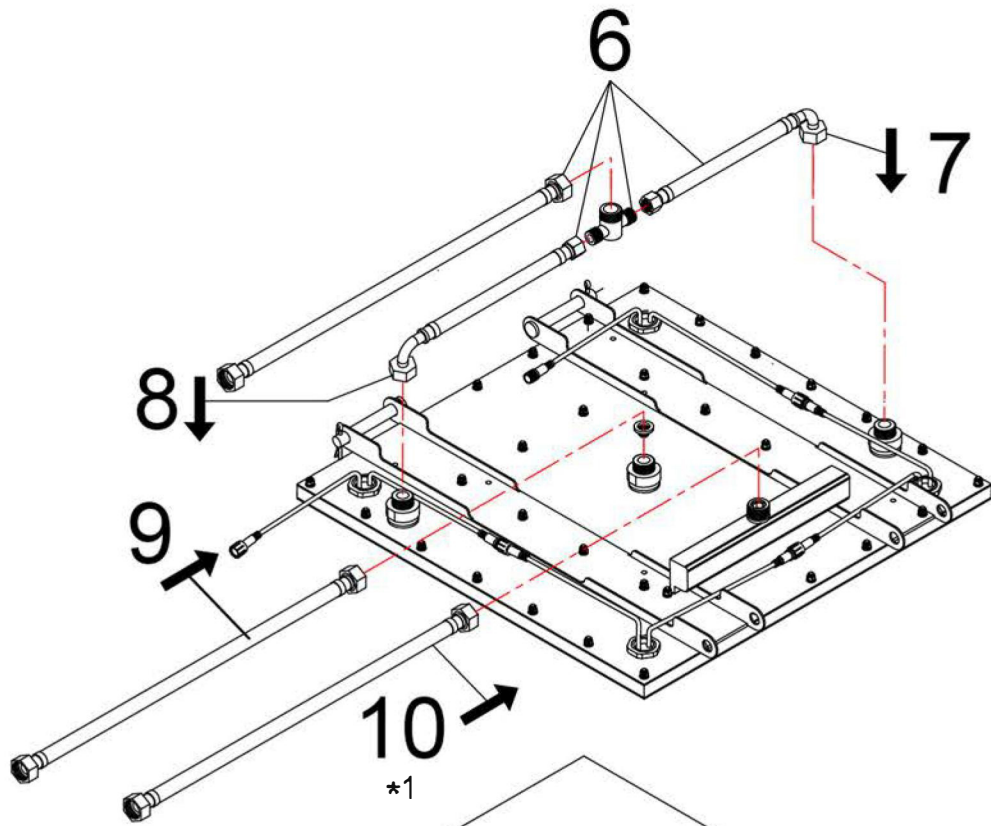

Installation

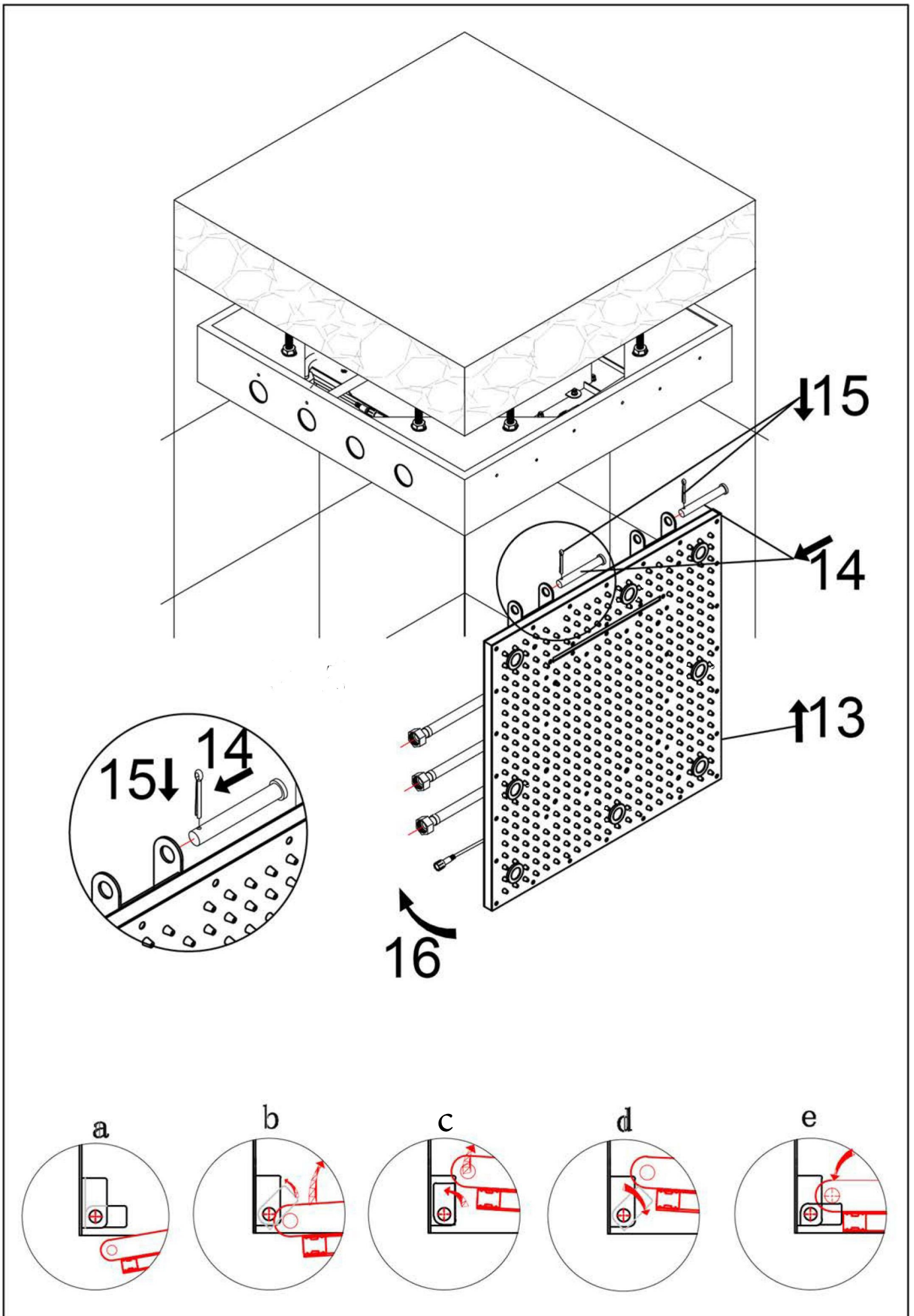

Installation

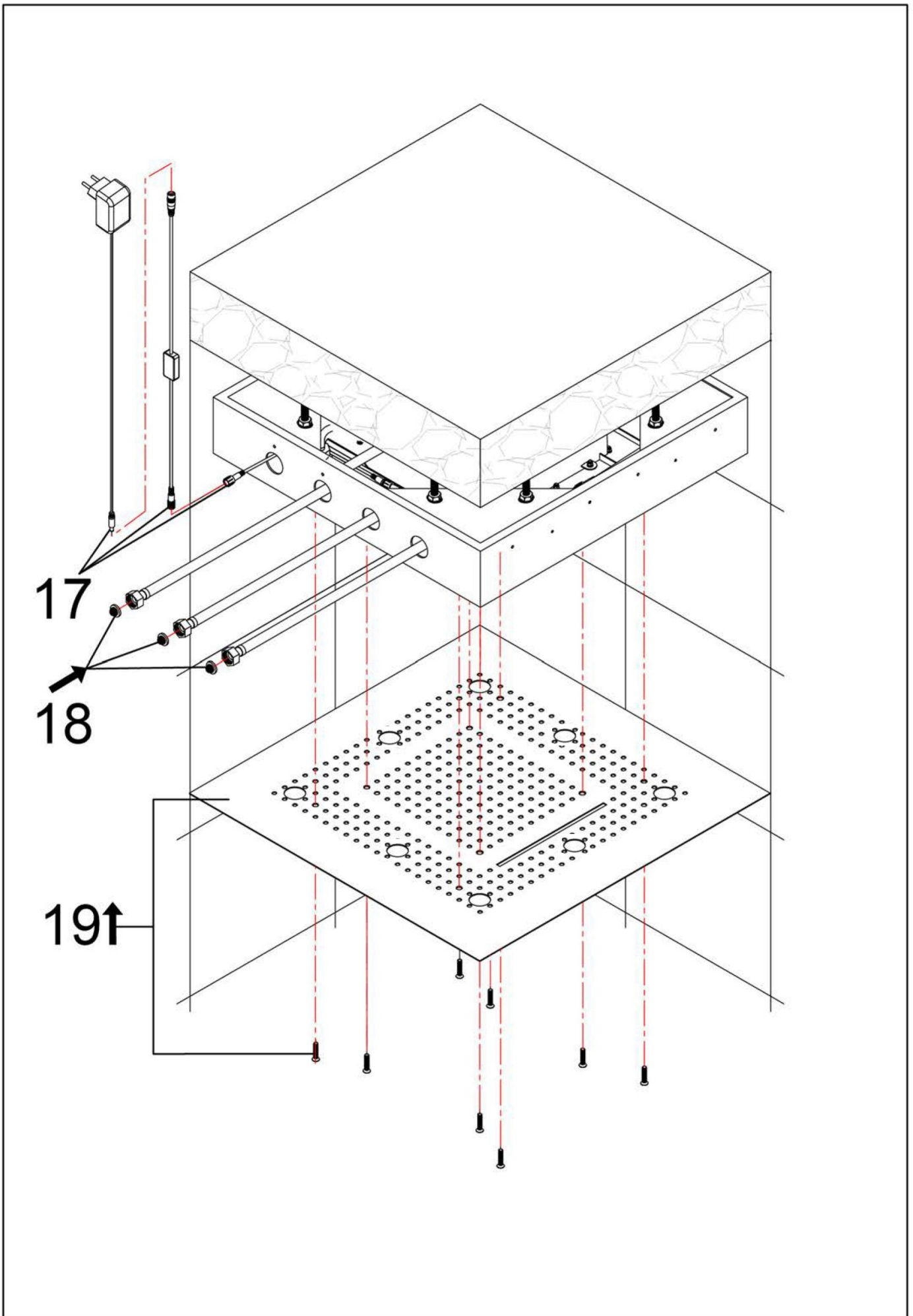

Installation

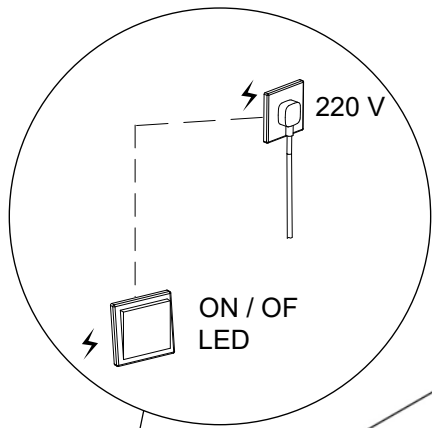

! Die LED-Beleuchtung kann ausschließlich nur über einen Lichtschalter betätigt werden
The LED lighting can only be operated via a light switch

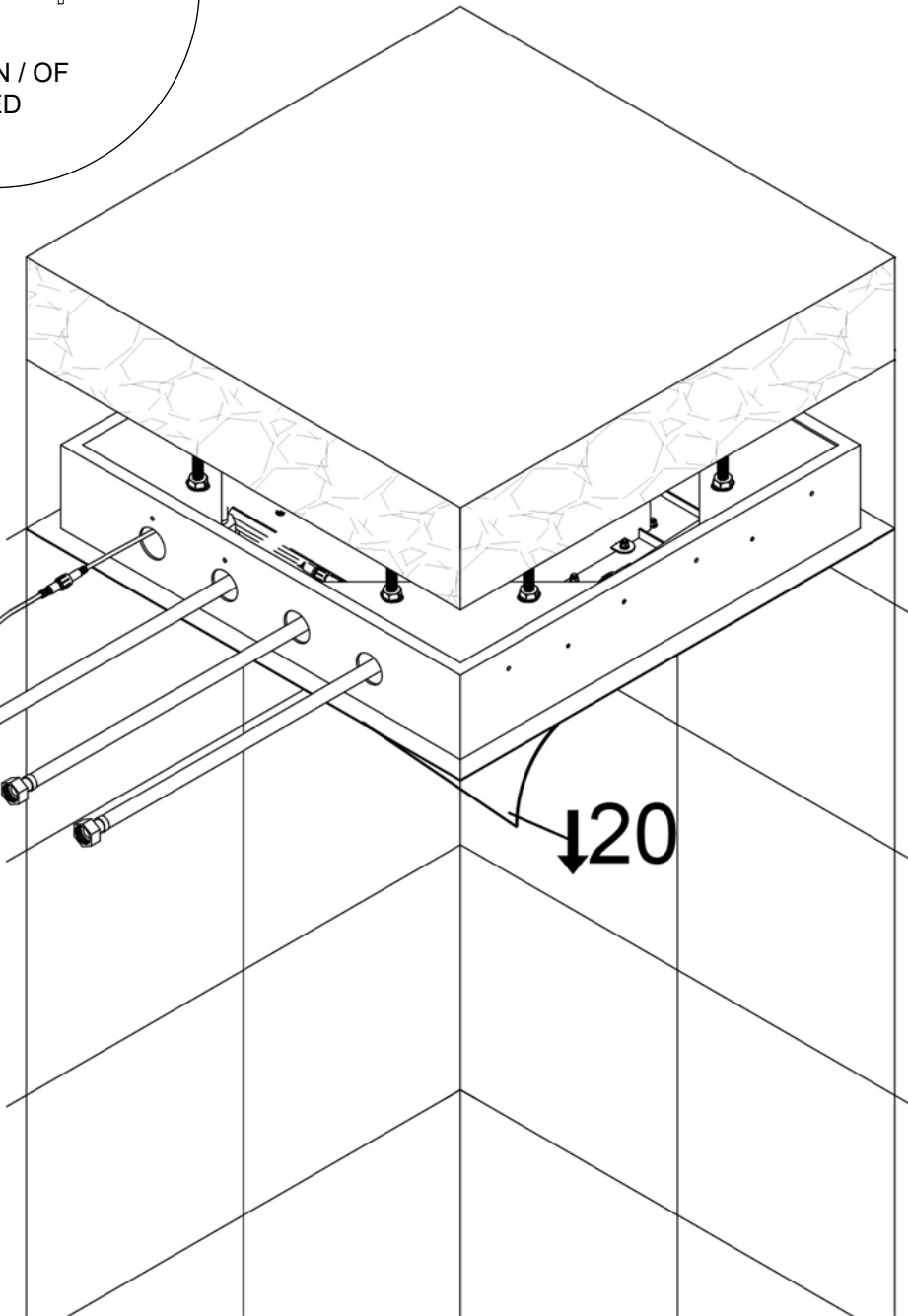
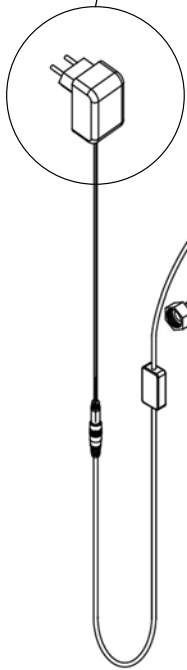

Funktion

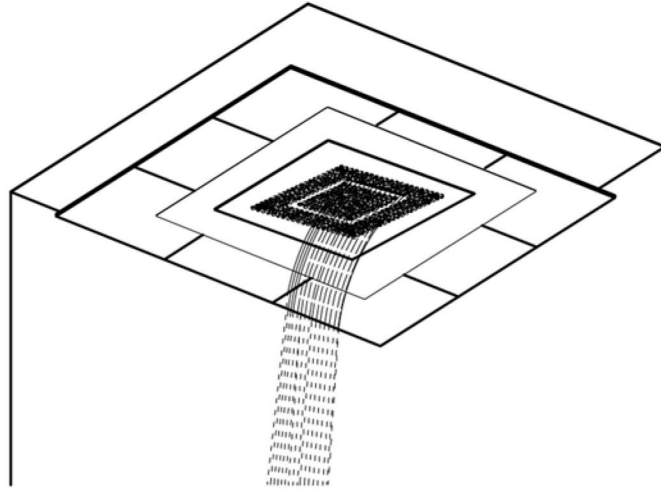

Waterfall

nur bei 6680 / only at 6680

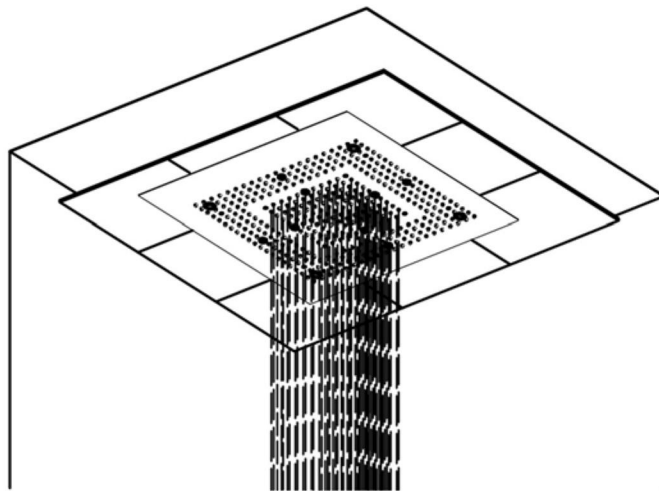

Rain

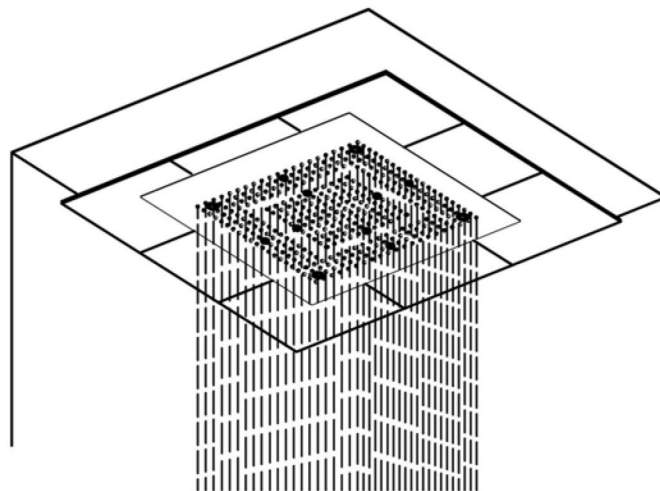

Nappe