

9 62 556/02

Kludi GmbH & Co. KG
Postfach 25 60
D-58685 Menden
Am Vogelsang 31-33
D-58706 Menden

Telefon: (D) +49 (0) 23 73 / 904-0
Telefax: (D) +49 (0) 23 73 / 904-4 65
E-Mail: info@kludi.de
Internet: www.kludi.com

KLUDI 
WATER IN PERFECTION

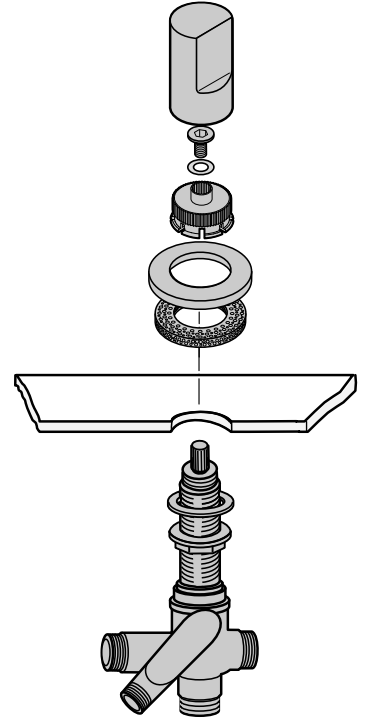
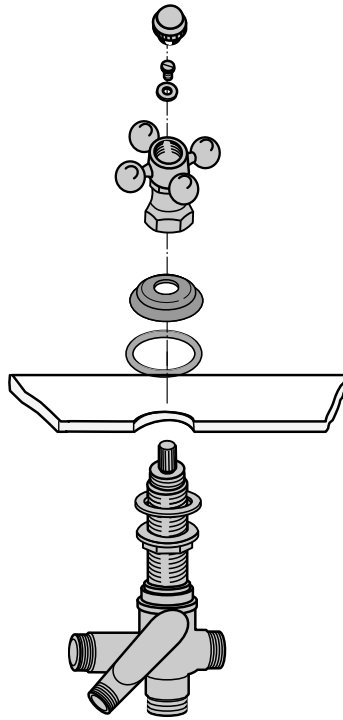
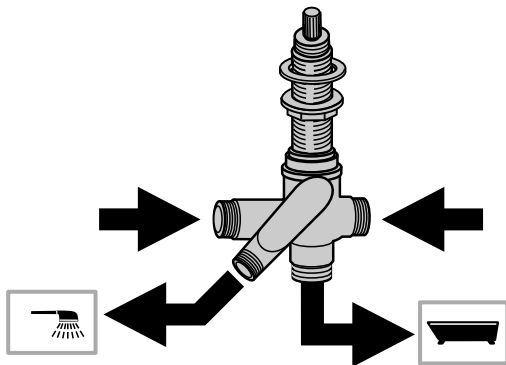
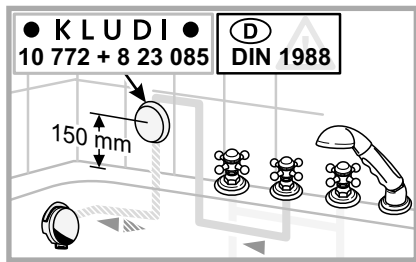

9 62 556/02

Kludi GmbH & Co. KG
Postfach 25 60
D-58685 Menden
Am Vogelsang 31-33
D-58706 Menden

Telefon: (D) +49 (0) 23 73 / 904-0
Telefax: (D) +49 (0) 23 73 / 904-4 65
E-Mail: info@kludi.de
Internet: www.kludi.com

KLUDI 
WATER IN PERFECTION