

DE Einbaumontage BetteWaschtische
EN Built in BetteWashbasins
FR Installation à encastrer BettePlan vasques
NL Inbouwmontage BetteWastafel

DE Montageanleitung
EN Installation instruction
FR Instructions de montage
NL Montagehandleiding

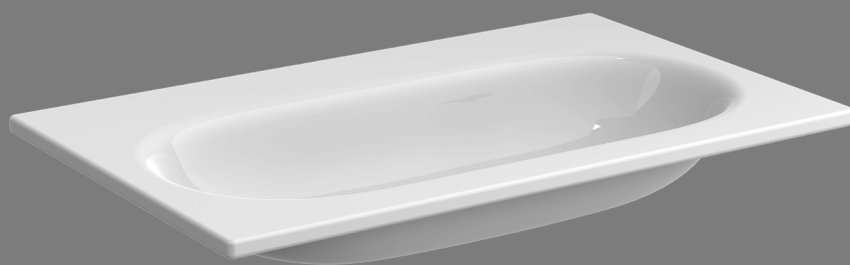

BETTE

Symbolerklärung



Verweis auf andere Produkte oder Dokumentationen



Ersatzteil



Optional



Korrekte Montage



Falsche Montage



Glas, zerbrechlich



Klebmontage

Sicherheitshinweise

- Eine Gewährleistung in Bezug auf Sicherheit, Funktion und Unversehrtheit des Produkts ist nur gegeben, wenn die Hinweise in dieser Anleitung beachtet werden. Bei Missachtung können Körperverletzungen und Sachschäden auftreten. Der Hersteller haftet nicht für Schäden, die durch Nichtbeachtung der Anweisungen eintreten.
- Gehen Sie unbedingt nach der Anweisung der Montageanleitung vor, um Montagefehler und Schäden am Produkt zu vermeiden.
- Beachten Sie neben den Hinweisen in dieser Anleitung die allgemein gültigen Sicherheits- und Unfallvorschriften.

Hinweise zur Anleitung

- Diese Montageanleitung muss während der gesamten Montage zur Verfügung stehen. Wenn die Montage von verschiedenen Personen (z.B. Installateur, Fliesenleger) durchgeführt wird, muss die Montageanleitung übergeben werden.
- Vorhandene Maßangaben sind in Millimeter (mm) angegeben.
- Die Abbildungen sind nicht maßstabsgerecht.
- Technische Änderungen sind vorbehalten

Montagehinweise

- Die Montage darf nur durch einen Fachmann erfolgen.
- Behandeln Sie das Produkt mit größter Sorgfalt, um Beschädigungen zu vermeiden. Ringe und andere Gegenstände, die das Produkt beschädigen können, müssen vor der Montage abgelegt werden.
- Der Bauuntergrund muss für die Aufnahme des Gewichtes geeignet sein.
- Schwere und sperrige Elemente müssen mit zwei Personen montiert werden.
- Starke Belastungen (z.B. Draufsetzen) können zu Beschädigungen an der Waschtischkonstruktion führen.
- Verwenden Sie zur Befestigung des Waschtisches auf der Trägerplatte handelsübliches Silikon oder Montagekleber.



Separate Dokumentationen (z. B. für Ablaufgarnituren) sind zu beachten.

Meaning of symbols



Cross reference to other products or documentation



Spare part



Optional



Correct installation



Incorrect installation



Glass, fragile



Adhesive mounting

Safety information

- The safety, function and integrity of the product can only be guaranteed if the information provided here is observed. Failure to do so may result in injury or damage to persons or property. The manufacturer is not liable for any damage resulting from a failure to observe the instructions.
- It is essential that you follow the instructions given in the installation guide in order to prevent installation errors and damage to the product.
- Please observe the general safety and accident prevention regulations in addition to the information provided in these instructions.

About this guide

- This installation guide must be available for the entire duration of the installation process. If the installation is to be carried out by several individuals (e.g. fitter, tiler etc.), then the installation guide must be passed on as appropriate.
- The dimensions are given in mm (millimetres).
- The illustrations are not true to scale.
- Subject to technical changes.

Installation information

- Only to be installed by qualified specialists.
- Handle the product with the greatest care in order to prevent damage. Rings and other items that could damage the product must be removed before installation.
- The underlying structure must be suitable for bearing the weight involved.
- Large, bulky or heavy items must be installed by two people.
- Use commercially available silicone or assembly adhesive to fix the washbasin to the support plate.



Separate documents (e. g. for drain sets) should be complied with.

Légende



Référence aux autres produits ou documentations



Pièce détachée



En option



Montage correct



Montage incorrect



Verre, fragile



Montage adhésif

Consignes de sécurité

- La sécurité, la fonctionnalité et l'intégrité du produit ne sont garanties que si les consignes fournies dans ce manuel sont respectées. Tout manquement à ce point peut entraîner des blessures corporelles et des dommages matériels. Le fabricant décline toute responsabilité pour les dommages survenus du fait du non respect des instructions.
- Procédez strictement comme indiqué dans le manuel de montage pour éviter toute erreur de montage et tout dommage du produit.
- Outre les consignes du présent manuel, tenez compte également des dispositions généralement en vigueur en matière de sécurité et de prévention des accidents.

Instructions

- Les présentes instructions doivent être disponibles durant tout le montage. Lorsque le montage est effectué par différentes personnes (par ex. installateur, carreleur), les instructions de montage doivent être transmises.
- Les cotes sont indiquées en millimètres (mm).
- Les illustrations ne sont pas à l'échelle.
- Sous réserve de modifications techniques.

Instructions de montage

- Le montage ne doit être réalisé que par du personnel qualifié.
- Manipulez le produit avec la plus grande précaution afin d'éviter tout dommage. Les bagues et autres objets susceptibles d'endommager le produit doivent être retirés avant le montage.
- Le support doit pouvoir supporter le poids de l'installation.
- Les éléments lourds et encombrants doivent être montés à l'aide de deux personnes.
- Pour fixer le vasque sur la plaque de support, utilisez du silicone ou de la colle de montage disponible dans le commerce.



Veuillez observer les documentations séparées (par ex. pour les garnitures d'écoulement).

Uitleg van de symbolen



Verwijzing naar andere producten
of documentatie



Reserveonderdeel



Optioneel



Correcte montage



Verkeerde montage



Glas, breekbaar



Zelfklevende montage

Veiligheidsinstructies

- Er is alleen sprake van een garantie met betrekking tot veiligheid, functie en intactheid van het product, als de opmerkingen in deze handleiding in acht worden genomen. Bij niet-naleving kunnen lichamelijk letsel en materiële schade optreden. De producent is niet aansprakelijk voor schade die door het niet in acht nemen van de aanwijzingen optreedt.
- Ga absoluut te werk volgens de aanwijzingen in de montagehandleiding, om montagefouten en schade aan het product te voorkomen.
- Neem naast de instructies in deze handleiding de algemeen geldige veiligheids- en ongevallenvoorschriften in acht.

Opmerkingen bij de handleiding

- Deze montagehandleiding moet tijdens de hele montage ter beschikking staan. Als de montage door verschillende personen (bijv. installateur, tegellegger) wordt uitgevoerd, moet de montagehandleiding overhandigd worden.
- Bestaande maataanduidingen zijn in millimeter (mm) aangegeven.
- De afbeeldingen zijn niet schaalgetrouw.
- Technische wijzigingen zijn voorbehouden.

Montage-instructies

- De montage mag uitsluitend door gekwalificeerd vakpersoneel plaatsvinden.
- Behandel het product uiterst zorgvuldig om beschadigingen te voorkomen. Ringen en andere voorwerpen die het product kunnen beschadigen, moeten vóór de montage worden afgedaan.
- De bouwondergrond moet geschikt zijn om het gewicht op te nemen.
- Zware en onhandzame onderdelen moeten met twee personen worden gemonteerd.
- Gebruik ter bevestiging van de wastafel op het topblad de in de handel verkrijgbare siliconen of montagelijm.



Afzonderlijke documentatie (bijv. voor afvoersets) moet in acht worden genomen.

DE Lieferumfang
 EN Scope of delivery
 FR Contenu de la livraison
 NL Leveringsomvang

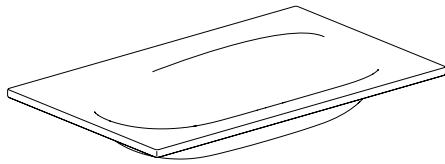

1x

Aqua: Z0018367

Comodo: Z0018365

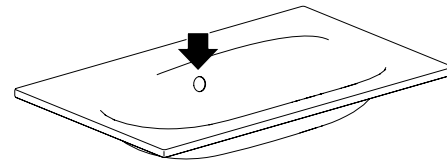
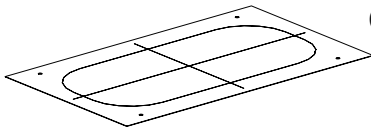

1x

One: Z0018366

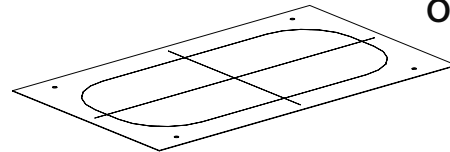

Z0016931
1x

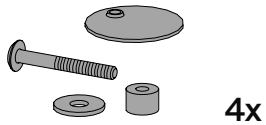

4x

Z0016931
1x

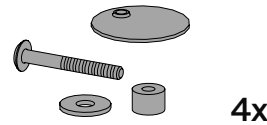

4x

Z0020247
1x



Z0017993
1x

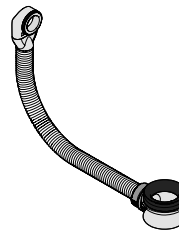

 BetteComodo

B616
1x

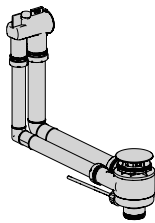



B581
1x





B580
1x

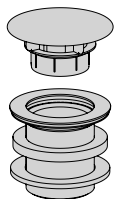

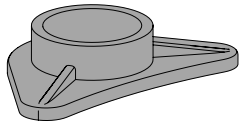
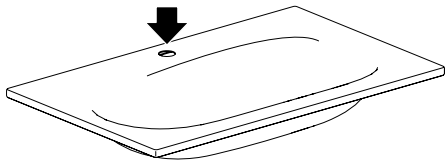

Z0015898
1x

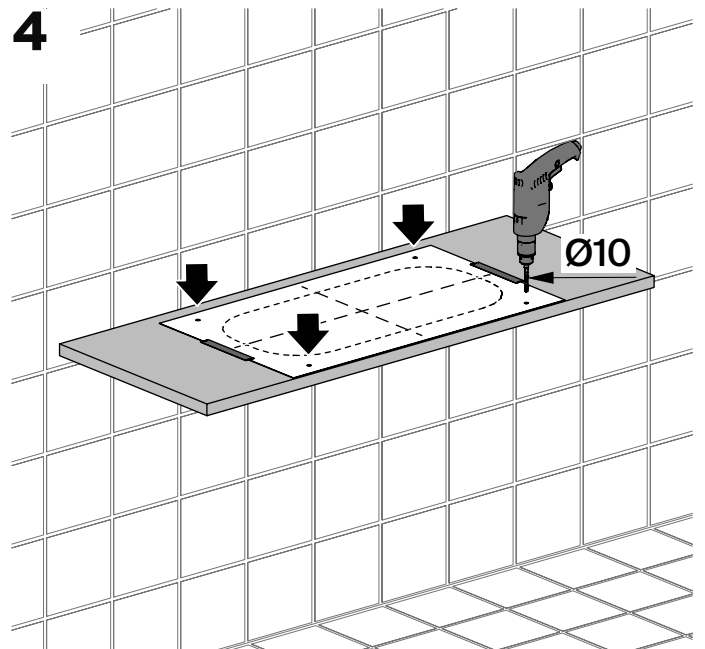
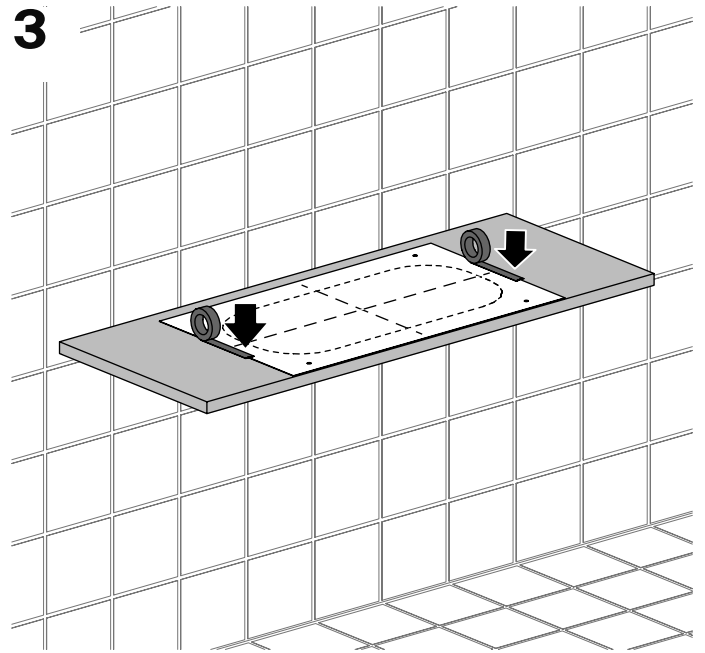
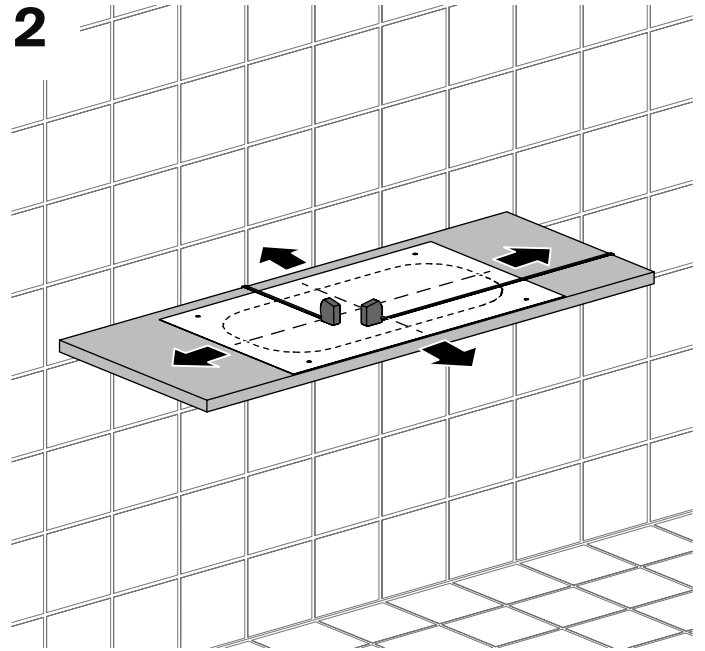
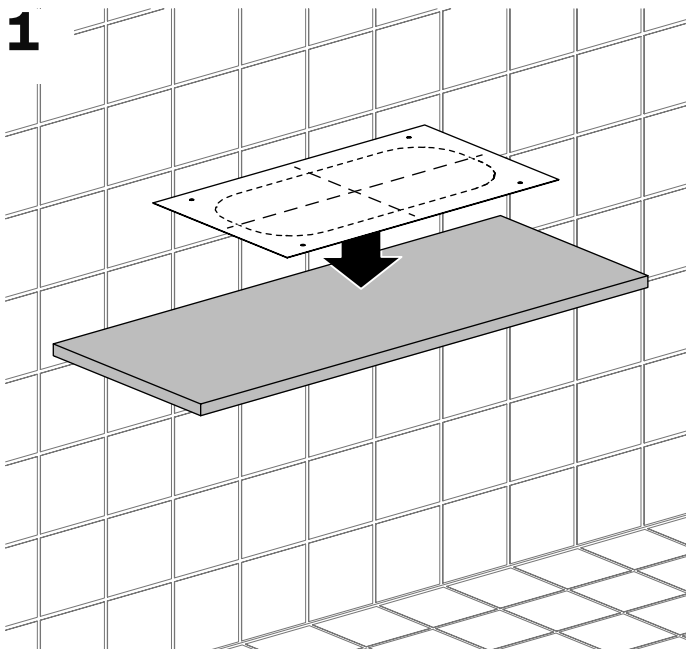
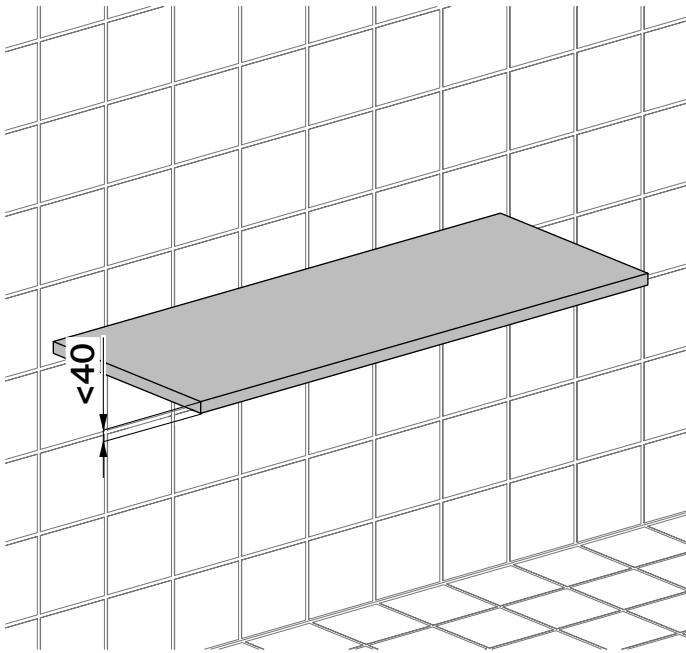

5

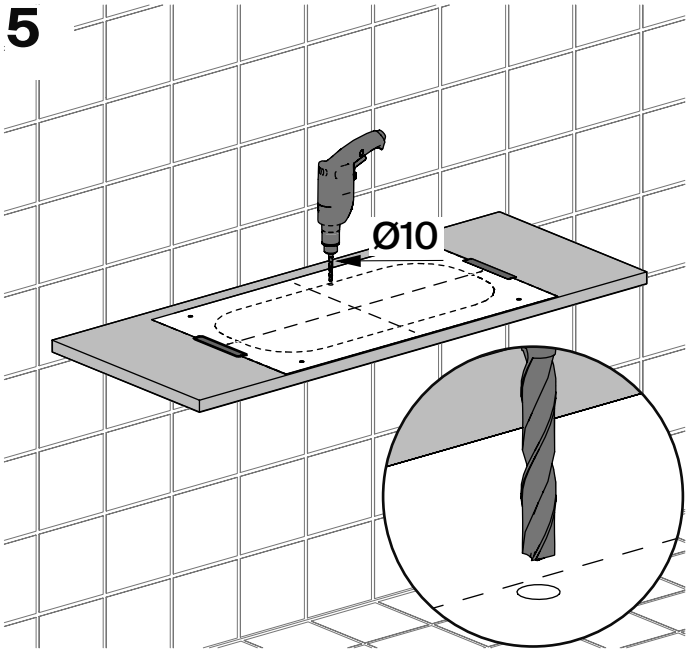

6

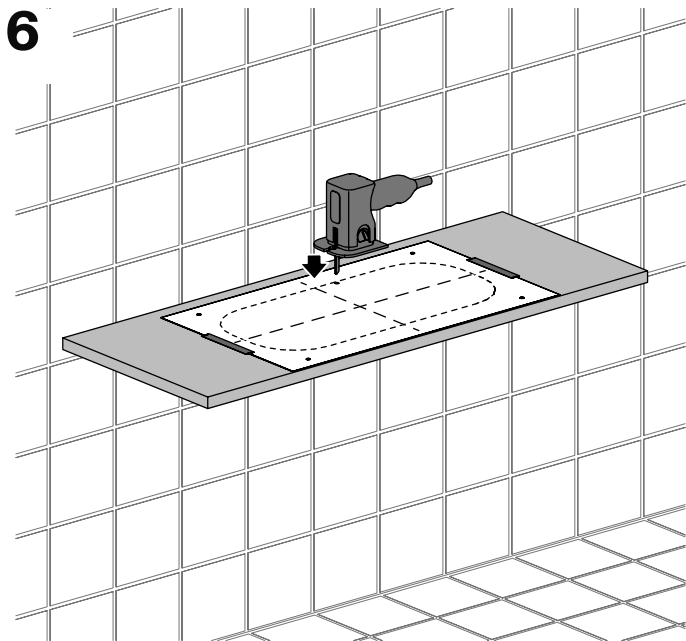

7

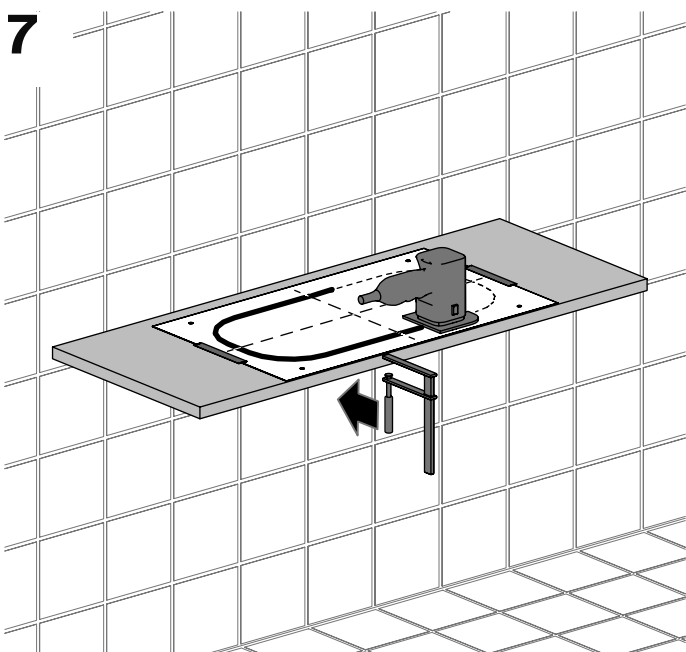

8

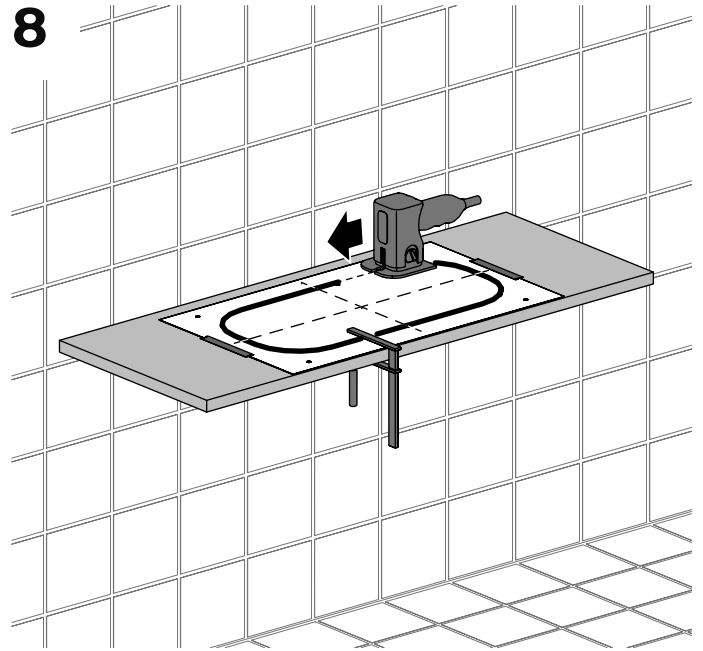

9

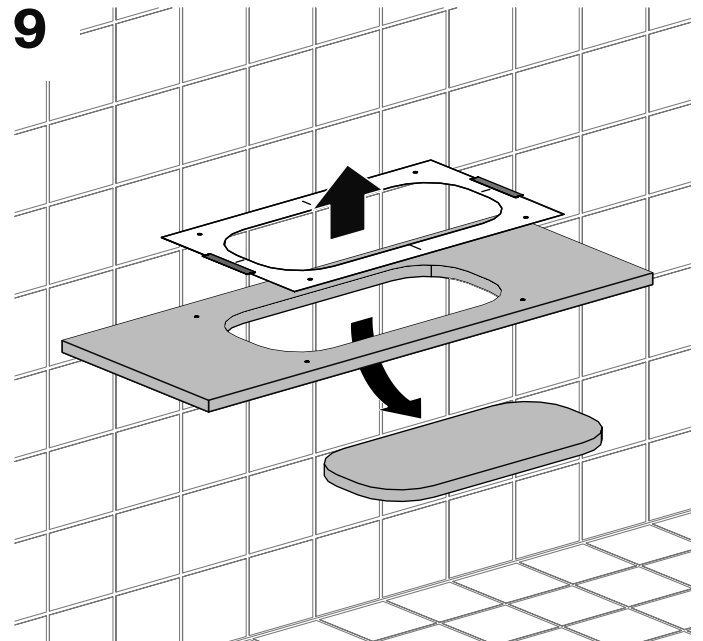

10

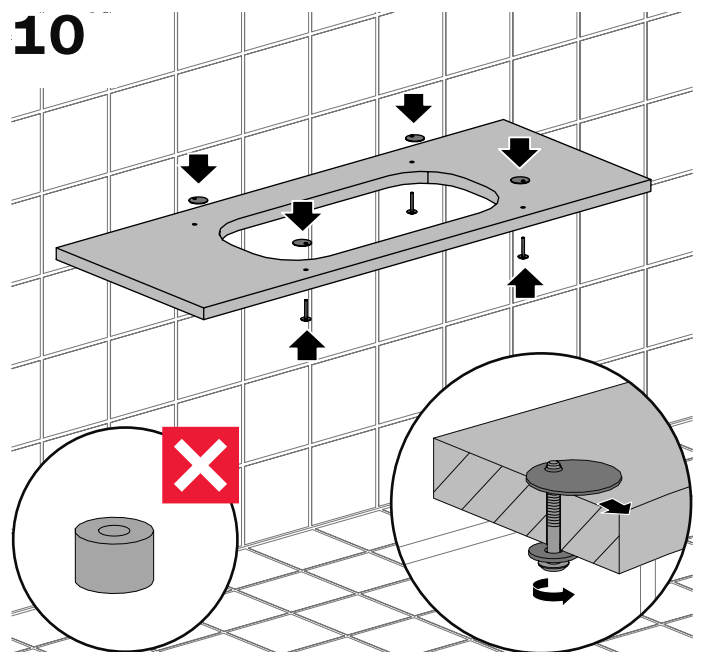

10A

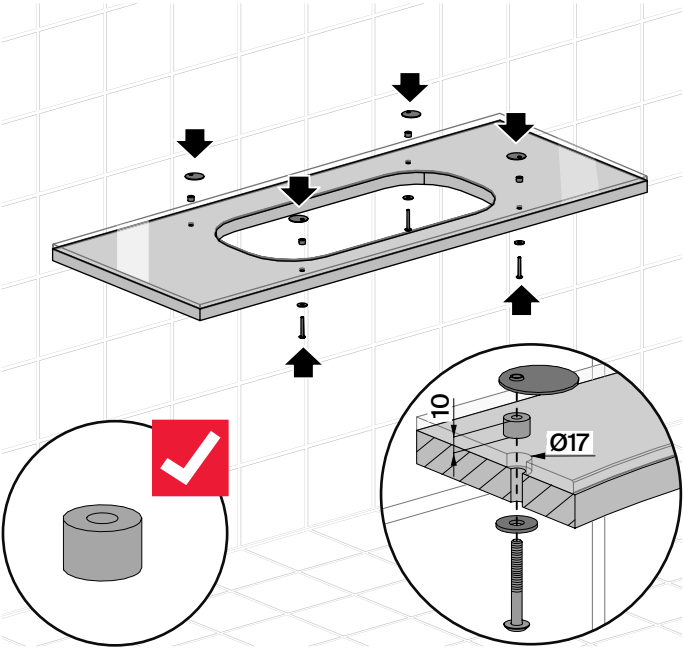
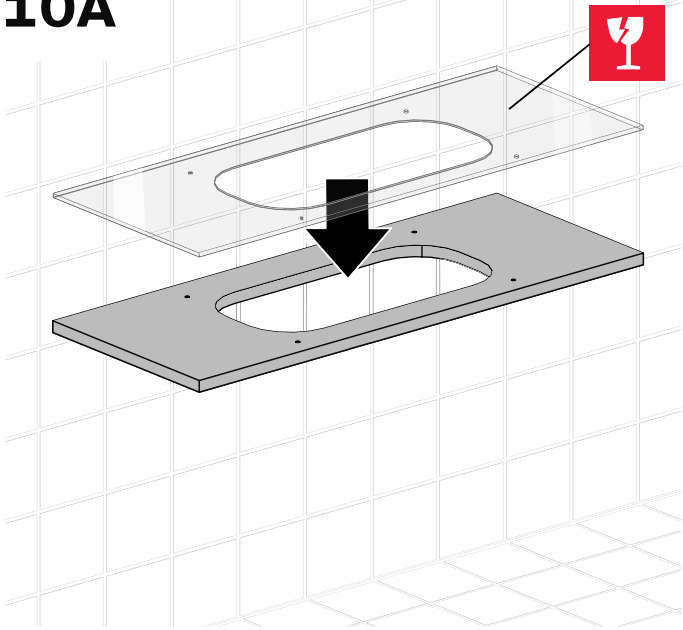

10B

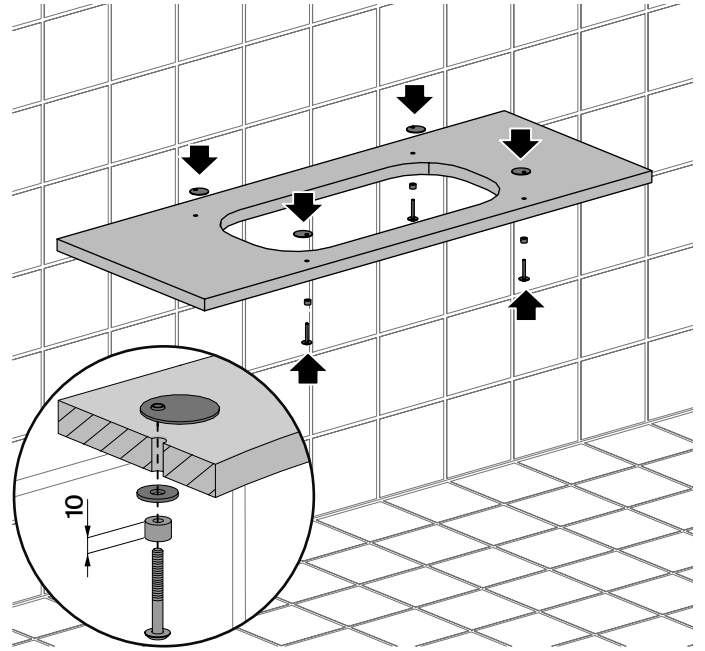
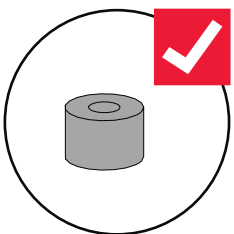
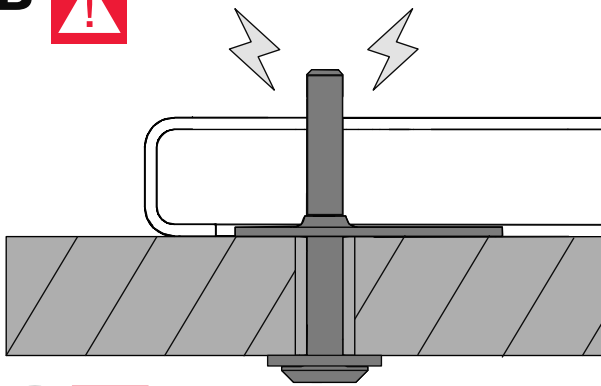

11

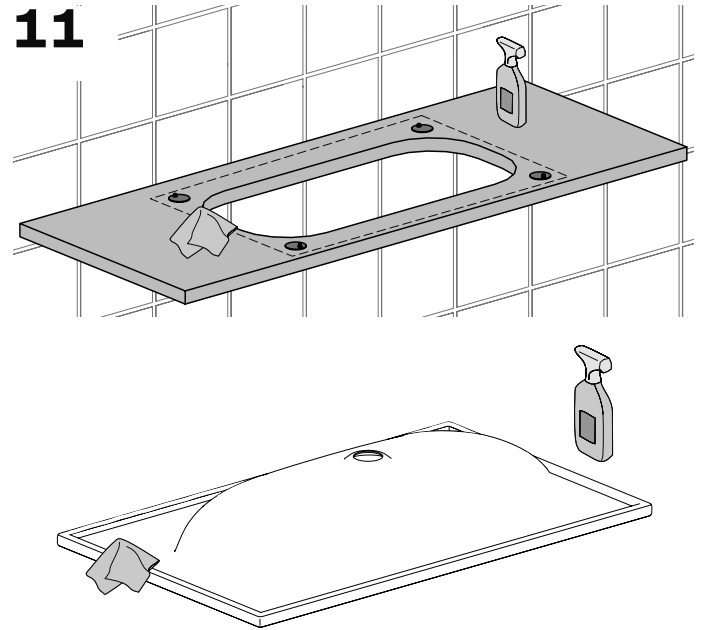

12

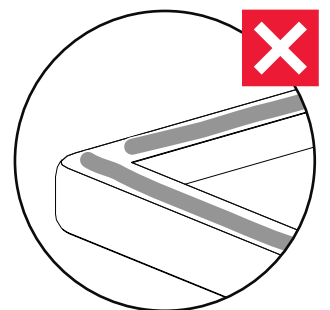
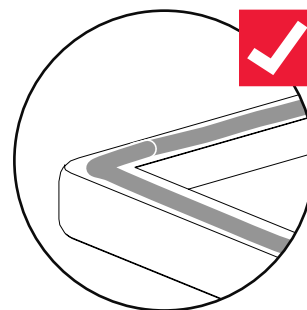
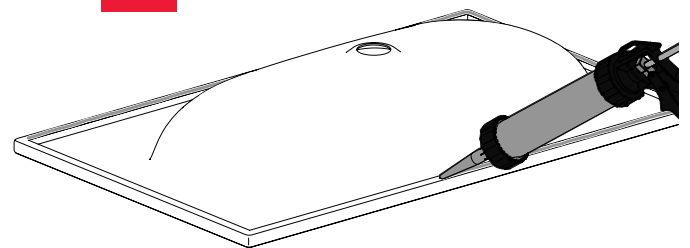

13

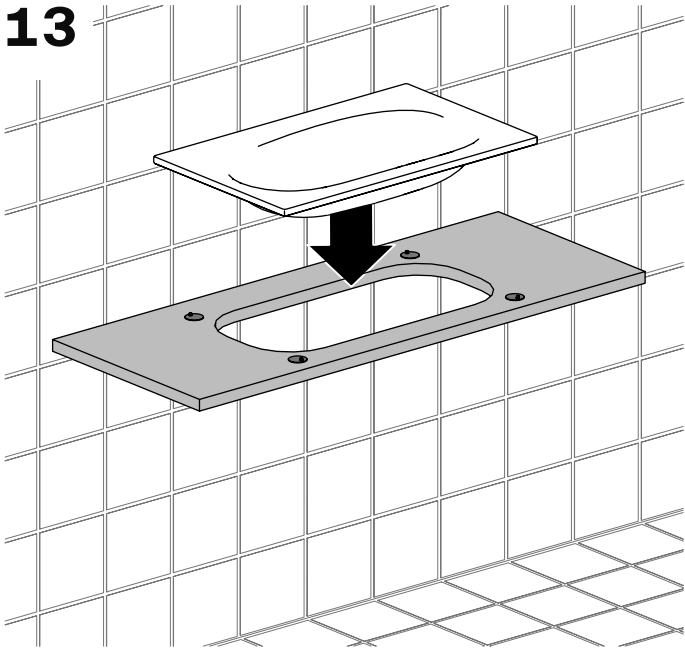

14

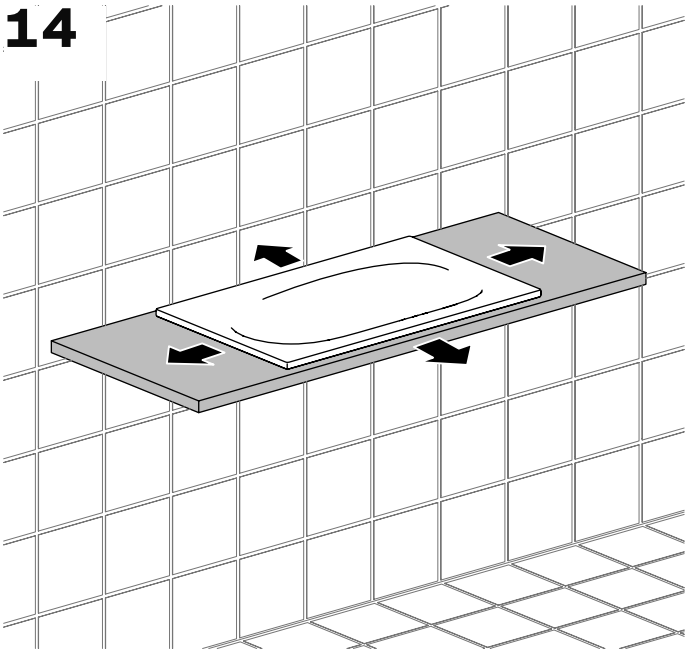

15

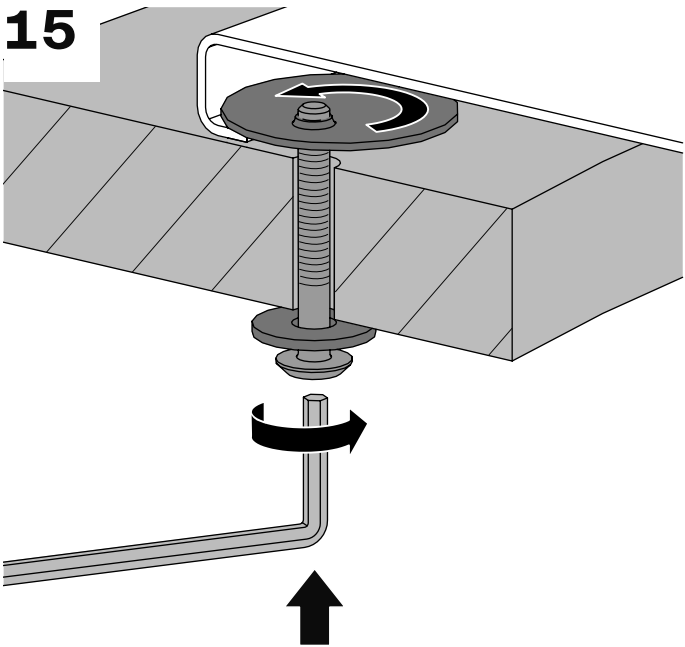

16

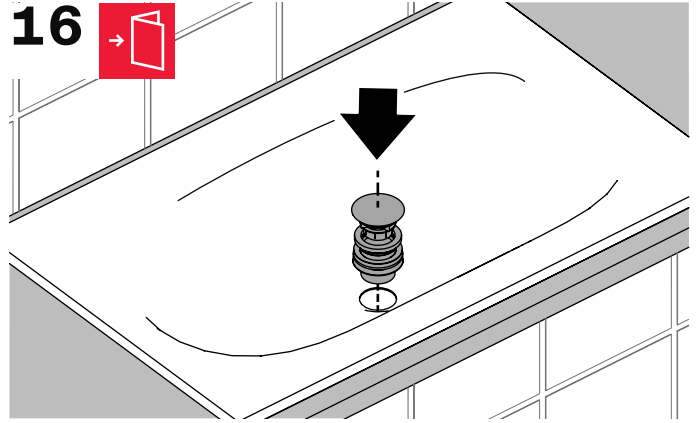

17

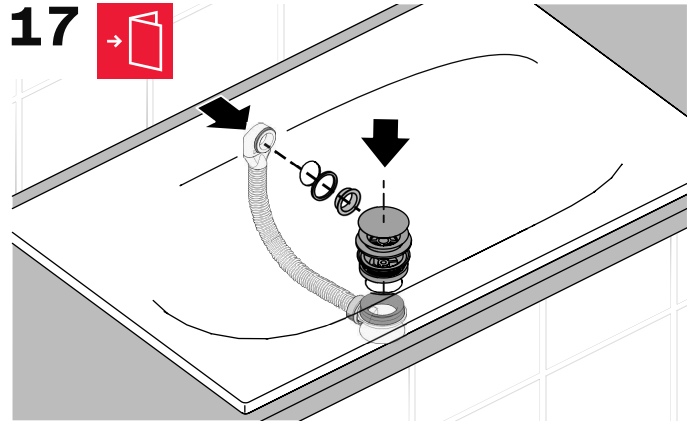

18

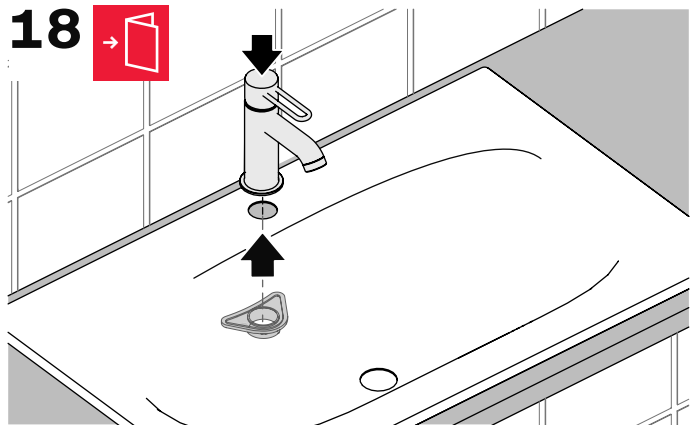

19

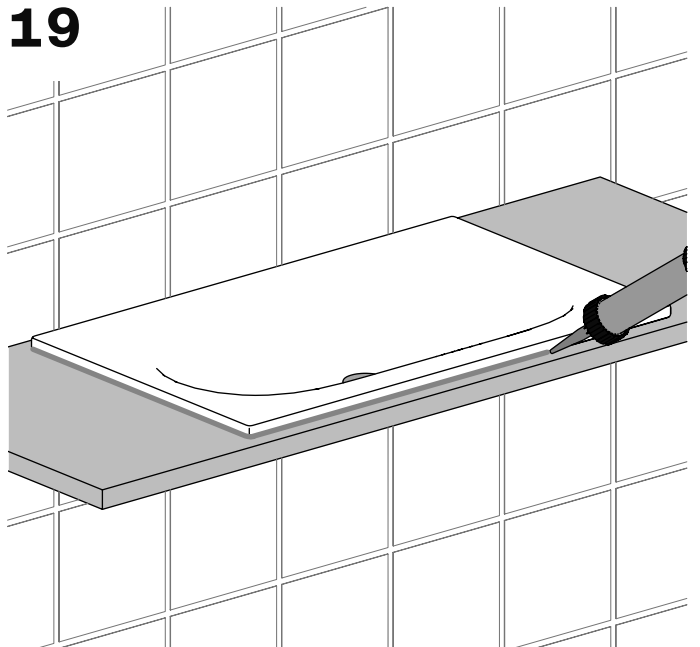

Bette GmbH & Co. KG
Heinrich-Bette-Straße 1
33129 Delbrück
Germany
T +49 5250 511-0
F +49 5250 511-130
info@bette.de

www.my-bette.com

Rev. 2 / 01.2024 / Z0018361