











90 24 02 083 00



	Chrom	90 24 02 083 00-00
	Platin gebürstet	90 24 02 083 00-06
	Platin	90 24 02 083 00-08
	Dark Brass matt	90 24 02 083 00-16
	Dark Bronze matt	90 24 02 083 00-17
	Dark Chrome	90 24 02 083 00-19
	Light Gold gebürstet	90 24 02 083 00-27
	Messing gebürstet (23kt Gold)	90 24 02 083 00-28
	Schwarz matt	90 24 02 083 00-33
	Chrom gebürstet	90 24 02 083 00-93
	Dark Platinum gebürstet	90 24 02 083 00-99



Gelenk für Bidet 40 x 38 x 14 mm - Chrom

ERSATZTEILE

90 24 02 083 00



Gelenk für Bidet 40 x 38 x 14 mm - Chrom

ERSATZTEILE

90 24 02 083 00

90 24 02 083 00

Ersatzteile für die
anderen
Oberflächenvarianten
finden Sie hier: Platin
gebürstet

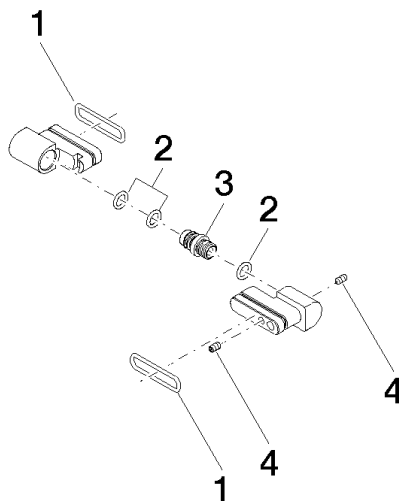

90.24.02.083.00-FF

Ersatzteilstückliste

Nr.	Artikelnummer	Benennung	Verbaumenge	Lieferzeit
4	09 31 11 081 90	Befestigung Gewindestift mit Innensechskant mit Ringschneide M3 x 6 mm -	2,00	2
1	09 14 10 053 90	O-Ring EPDM 70 17,17 x 1,78 mm -	2,00	2
3	09 24 03 222 20-00	Nippel	1,00	60
2	09 14 10 132 90	O-Ring EPDM 70 6,0 x 1,5 mm -	3,00	2