













**META Wannen-Einhandbatterie für Wannenrand- bzw. Fliesenrandmontage -
Platin gebürstet**

META

29 300 660 Produktversion ab 01.07.2023



- Bohrungsdurchmesser 35 mm
- Durchfluss max. 35,7 l/min bei 3 bar Fließdruck

	Platin gebürstet	29 300 660-06
	Chrom	29 300 660-00
	Dark Chrome	29 300 660-19
	Light Gold	29 300 660-26
	Light Gold gebürstet	29 300 660-27
	Schwarz matt	29 300 660-33
	Bronze gebürstet	29 300 660-42
	Champagne gebürstet (22kt Gold)	29 300 660-46
	Champagne (22kt Gold)	29 300 660-47
	Cyprum	29 300 660-49
	Chrom gebürstet	29 300 660-93
	Dark Platinum gebürstet	29 300 660-99

29 300 660 Produktversion ab 01.07.2023
mm [inches]

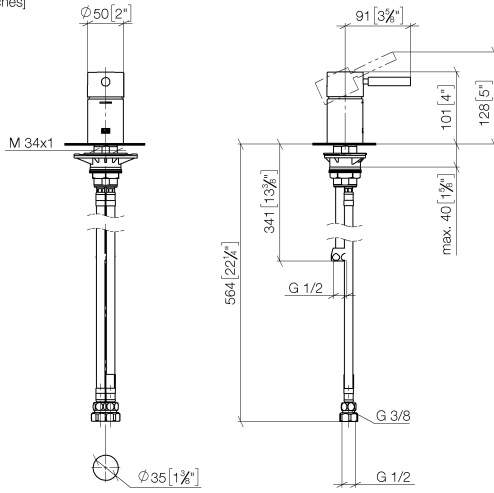

Durchflussdiagramm

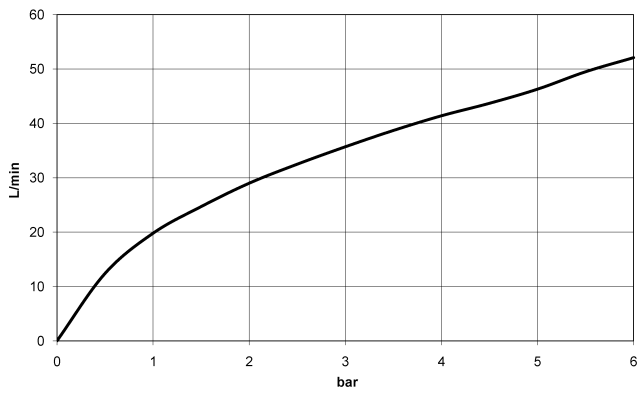

Codes & Standards

ASME A112.18.1

cUPC

Scottish Water
Byelaws

UK Water Supply
Regulations



**META Wannen-Einhandbatterie für Wannenrand- bzw. Fliesenrandmontage -
Platin gebürstet**

META

29 300 660 Produktversion ab 01.07.2023

Zertifikate

WRAS_2004

IAPMO_4976

29 300 660 Produktversion ab 01.07.2023

Ersatzteile für die
anderen
Oberflächenvarianten
finden Sie hier:
Chrom

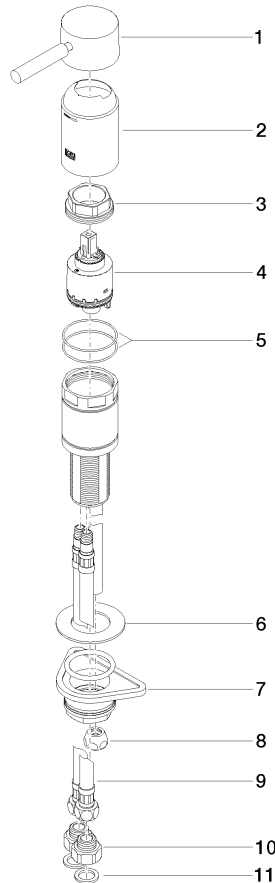

Ersatzteilstückliste

Nr.	Artikelnummer	Benennung	Verbaumenge	Lieferzeit
10	09 24 03 185-00	Nippel Reduziernippel 1/2" x 3/8" - Chrom	2,00	10
4	90 15 05 039 00 90	Kartusche blau Ø 40 x 75 mm -	1,00	2
8	04 23 30 041 00 90	Anschluss Ø 12 mm x 1/2" -	1,00	2
5	09 14 10 201 90	O-Ring EPDM 70 45,0 x 1,5 mm -	1,00	2
1	90 20 66 005 00-06	Griff für Wanne Stand Hebel 52 x 35 x 117 mm - Platin gebürstet	1,00	10
3	09 24 04 448 90	Befestigung Mutter Ø 42 x 17 mm -	1,00	2
7	04 23 10 044 02 90	Befestigung mit Dichtungen M34 x 1 -	1,00	2
11	09 14 05 004 90	Dichtung EPDM 70 20,8 x 14,5 x 2,0 mm -	2,00	2
2	09 28 30 037-06	Haube DB Logo Ø 50 x 76,8 mm - Platin gebürstet	1,00	10
9	04 30 04 021 00 90	Druckschlauch mit Überwurfmutter M10x1 x 3/8" x 500 mm -	1,00	2
6	09 30 11 060 90	Scheibe 60 x 34 x 2 mm -	1,00	2