

















83 510 892 Produktversion ab 01.04.2024



- Breite 152 mm
- Höhe 100 mm
- Rosette Ø 55 mm
- Ausladung 77 mm

	Schwarz matt	83 510 892-33
	Chrom	83 510 892-00
	Chrom	83 510 892-0015
	Platin gebürstet	83 510 892-06
	Platin	83 510 892-08
	Weiß matt	83 510 892-10
	Dark Brass matt	83 510 892-16
	Dark Bronze matt	83 510 892-17
	Dark Chrome	83 510 892-19
	Light Gold gebürstet	83 510 892-27
	Messing gebürstet (23kt Gold)	83 510 892-28
	Bronze gebürstet	83 510 892-42
	Champagne gebürstet (22kt Gold)	83 510 892-46
	Champagne (22kt Gold)	83 510 892-47
	Chrom gebürstet	83 510 892-93
	Dark Platinum gebürstet	83 510 892-99

83 510 892 Produktversion ab 01.04.2024

mm [inches]

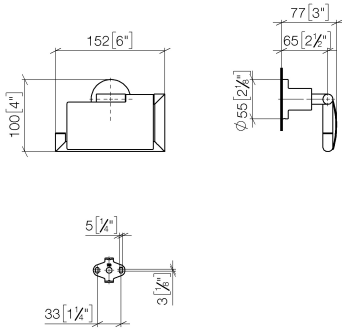

83 510 892 Produktversion ab 01.04.2024

Ersatzteile für die  
anderen  
Oberflächenvarianten  
finden Sie hier:  
Chrom

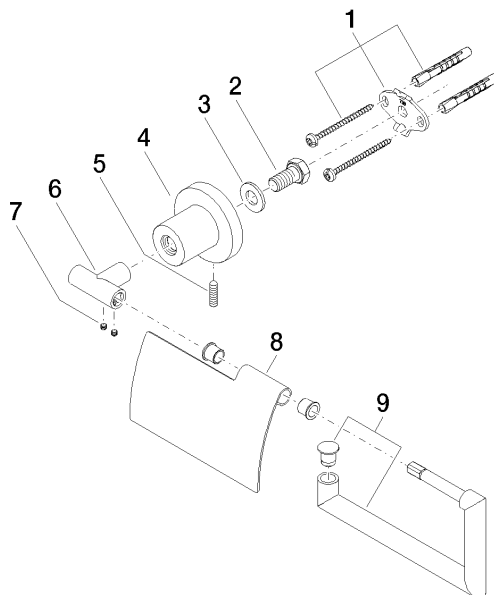

## Ersatzteilstückliste

Nr.	Artikelnummer	Benennung	Verbaumenge	Lieferzeit
2	09 30 30 071 90	Befestigung Sechskantschraube mit Gewinde bis Kopf M10 x 20 mm -	1,00	2
8	08 11 02 514-33	Abdeckung für Papierrollenhalter 120 x 77 x 18 mm - Schwarz matt	1,00	30
4	08 17 89 505-33	Halter universal 60 x 100 x 60 mm - Schwarz matt	1,00	30
9	90 28 22 641 00-33	Halter 154 x 80 x 17 mm - Schwarz matt	1,00	30
5	04 31 11 113 00 90	Befestigung Gewindestift M5 x 12 mm -	1,00	2
1	05 17 20 739 00 90	Befestigungssatz 150 x 65 x 10 mm -	1,00	2
6	05 17 89 553 00-33	Halter für Papierrollenhalter mit Deckel 31,5 x 14 x 40 mm - Schwarz matt	1,00	30
3	09 30 11 046 90	Unterlegscheibe Ø 10,5 -	1,00	2
7	90 31 11 038 00 90	Befestigung Gewindestift mit Innensechskant mit Ringschneide M4 x 3 mm -	2,00	2