

















10 105 970 Produktversion ab 01.04.0205



	Messing gebürstet (23kt Gold)	10 105 970-28
	Chrom	10 105 970-00
	Gold (23,9kt)	10 105 970-01
	chrom gebürstet (04)	10 105 970-04
	Platin gebürstet	10 105 970-06
	Platin	10 105 970-08
	Messing (23kt Gold)	10 105 970-09
	Weiß matt	10 105 970-10
	weiß	10 105 970-12
	schwarz	10 105 970-13
	Gold gebürstet (23,9kt)	10 105 970-14
	Dark Brass matt	10 105 970-16
	Dark Bronze matt	10 105 970-17
	Dark Chrome	10 105 970-19
	Light Gold	10 105 970-26
	Light Gold gebürstet	10 105 970-27
	Schwarz matt	10 105 970-33
	chrom satin	10 105 970-41
	Bronze gebürstet	10 105 970-42
	Champagne gebürstet (22kt Gold)	10 105 970-46
	Champagne (22kt Gold)	10 105 970-47
	Cyprum	10 105 970-49
	Chrom gebürstet	10 105 970-93
	Dark Platin gebürstet	10 105 970-99
	royalblau	10 105 970-36



Siebventil 1 1/4" - Messing gebürstet (23kt Gold)

SERIENNEUTRAL

10 105 970 Produktversion ab 01.04.0205

Nur für Becken mit Überlauf geeignet.

10 105 970 Produktversion ab 01.04.0205

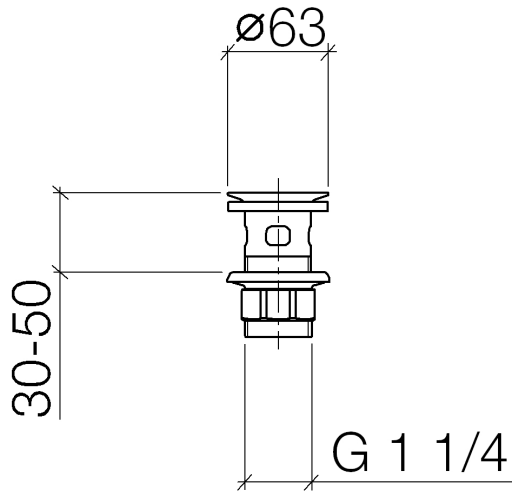

10 105 970 Produktversion ab 01.04.0205

Ersatzteile für die
anderen
Oberflächenvarianten
finden Sie hier:
Chrom

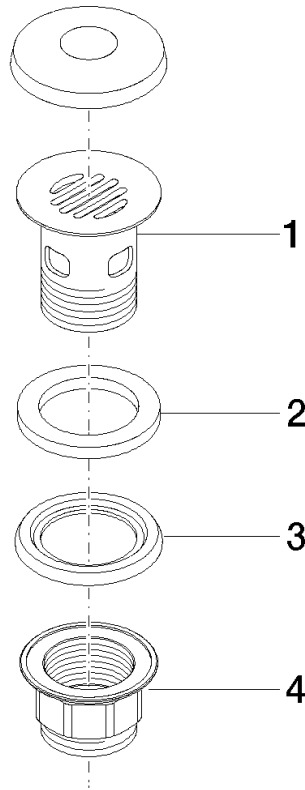

Ersatzteilstückliste

Nr.	Artikelnummer	Benennung	Verbaumenge	Lieferzeit
2	09 14 05 039 90	Dichtung 43,5 x 62 x 6 mm -	1,00	2
4	09 23 10 020-28	Befestigung Ø 60 x 36,5 mm - Messing gebürstet (23kt Gold)	1,00	20
1	09 11 01 027-28	Kelch für Ablaufgarnitur Siebventil 1 1/4" - Messing gebürstet (23kt Gold)	1,00	20
3	09 14 03 025 90	Dichtung Profildichtung Ø 64 x 6 mm -	1,00	2