







13 801 845 Produktversion ab 09.03.2016



- Ausladung 210 mm
- runder Normalstrahl
- Bohrungsdurchmesser 37 mm
- Anschluss 1/2"
- Steckanschluss-Montage
- Durchfluss max. 21,5 l/min bei 3 bar Fließdruck

	Platin gebürstet	13 801 845-06
	Chrom	13 801 845-00
	Dark Chrome	13 801 845-19
	Light Gold gebürstet	13 801 845-27
	Schwarz matt	13 801 845-33
	Chrom gebürstet	13 801 845-93
	Dark Platin gebürstet	13 801 845-99

Empfohlenes Zubehör

UP-Wandwinkel - 35 085 970 90



- Min. Einbautiefe 90 mm
- Max. Einbautiefe 163 mm

13 801 845 Produktversion ab 09.03.2016

mm [inches]

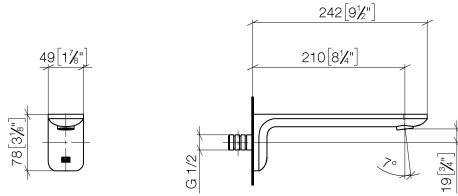

Durchflussdiagramm

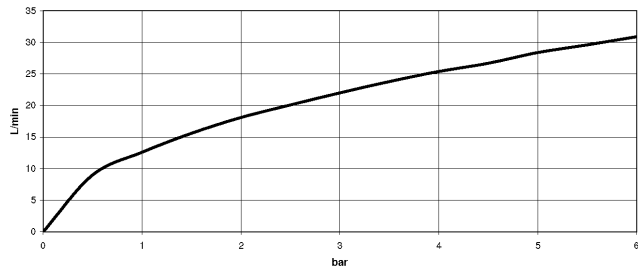

Codes & Standards

ASME A112.18.1	cUPC	DIN 4109	ISO 3822
Scottish Water Byelaws	UK Water Supply Regulations	Ü-Zeichen	



LISSÉ Wannenauslauf für Wandmontage - Platin gebürstet

LISSÉ

13 801 845 Produktversion ab 09.03.2016

Zertifikate

IAPMO_4976

LGA_29

WRAS_2207

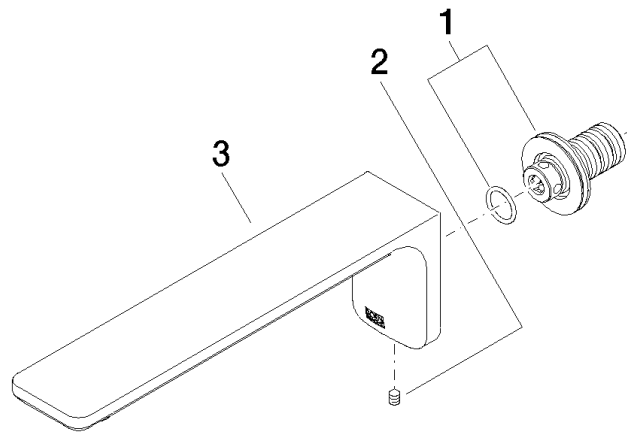

Ersatzteilstückliste

Nr.	Artikelnummer	Benennung	Verbaumenge	Lieferzeit
3	90 11 84 014 02-06	Auslauf 210 mm, 22 l/min. - Platin gebürstet	1,00	10
2	90 31 11 004 00 90	Befestigung -	1,00	2
1	90 24 03 108 00 90	Nippel Ø 40 x 50 mm, 5 l/min. -	1,00	2